

MODELL CC

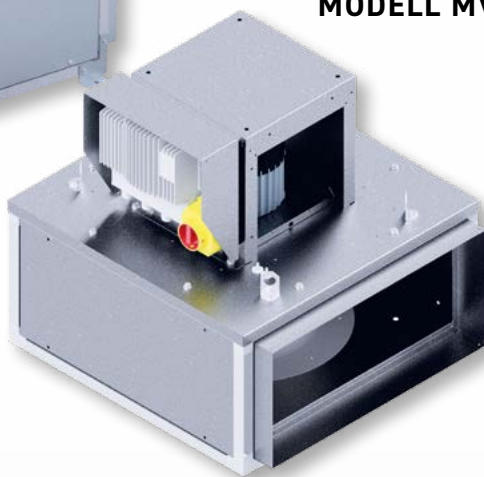

MODELL MV



Multifunktionale Kanalventilatoren zum Einsatz in gewerblichen Küchen und industriellen Prozessanwendungen, nur in Verbindung mit CAIB/T PRO-REG Zuluftgeräten.

Die Motoren sind vom Luftstrom getrennt und fremdbelüftet.

Rückwärts gekrümmte Radiallaufräder, mit energieeffizienten EC-Außenläufermotoren.

Modulare Rahmenkonstruktion aus Aluminium-Hohlprofilen, Seitenwände Stahlblech, verzinkt

Schalldämmauskleidung 25 mm, nicht brennbar (M0).

Zur Außenaufstellung geeignet. Montage in horizontaler oder vertikaler Achslage möglich. Ansaug- und Ausblasstutzen rechteckig (2 Stück ILBA

Kanalanschlussstutzen im Lieferumfang), Ausblasöffnung variabel. Seitenwände und Deckel zu Revisionszwecken abnehmbar. 4 Stück Montagehalterungen im

Lieferumfang enthalten.

Kondensatablaufstutzen liegt lose bei Montage je nach Aufstellung

ILHB / ILHT ECOWATT CC
Modell mit Luftsammelkasten, mit multidirektionalen Anschlüssen.

ILHB / ILHT ECOWATT MV

Modell mit quadratischem Anschluss.

EC-Motoren, Wärmeklasse F, Schutzart IP 55
interne Thermokontakte Motorbemessung
Dauerbetrieb S1 Geschlossene Kugellager
- wartungsfrei.

100% drehzahlregelbar über 0-10 V Signal.

ILHB ECOWATT ASR

Spannungsversorgung 1~ 230 V, 50/60 Hz

ILHT ECOWATT ASR

Spannungsversorgung 3~400 V, 50/60 Hz

Klemmenkasten mit Wartungsschalter.

Fördermitteltemperatur:

-20°C bis 120°C.

Das ASR-SYSTEM ermöglicht die Einrichtung eines gemeinsam geregelten ZU- und AB-Luftsystems für gewerbliche Küchen:

- Parametrierung von Zu- und Abluft, auch bei ungleichen Mengenverhältnissen (z.B. Unterdruck)
- Anzeige und Anpassung des aktuellen Volumenstromes
- Temperaturregelung zur Zuluft
- Komfort- und Entrauchungsbetrieb

NUR in Verbindung mit einem Zuluftgerät der CAIB / CAIT PRO-REG Serie



TECHNISCHE DATEN

Überprüfen Sie vor der Installation, ob die auf dem Typenschild angegebenen elektrischen Eigenschaften des Produkts (Spannung, Leistung, Frequenz usw.) mit denen der vorgesehenen Stromversorgung übereinstimmen.

Modell	Artikel Nr.	Drehzahl [min ⁻¹]	Leistungs- aufnahme max. [W]	Motorstrom [A]	Volumenstrom (freibl.) [m ³ /h]	Schalldruckpegel* [dB(A)]			Gewicht [kg]
						Saugseite	Abstrahlung	Druckseite	
Wechselstrom 1~ 230V, 50/60 Hz, EC-Motor									
ILHB-355 CC ECOWATT ASR	5133033200	1420	0,70	3,1	3.980	63	55	68	65
ILHB-400 CC ECOWATT ASR	5133033300	1500	0,72	3,1	5.060	61	53	67	78
ILHB-450 CC ECOWATT ASR	5133033400	1500	1,24	5,4	7.300	66	59	72	98
Drehstrom 3~ 400V, 50/60 Hz, EC-Motor									
ILHT-500 CC ECOWATT ASR	5133033500	1500	1,70	3,5	9.140	67	59	75	120
ILHT-630 CC ECOWATT ASR	5133033600	1130	3,16	7,0	11.820	68	58	72	177
ILHT-710 CC ECOWATT ASR	5133033700	1250	5,91	12,4	24.120	73	66	79	279

Modell	Artikel Nr.	Drehzahl [min ⁻¹]	Leistungs- aufnahme max. [W]	Motorstrom [A]	Volumenstrom (freibl.) [m ³ /h]	Schalldruckpegel* [dB(A)]			Gewicht [kg]
						Saugseite	Abstrahlung	Druckseite	
Wechselstrom 1~ 230V, 50/60 Hz, EC-Motor									
ILHB-355 MV ECOWATT ASR	5133032400	1830	0,70	3,1	4.230	62	51	64	44
ILHB-400 MV ECOWATT ASR	5133032500	1500	0,72	3,1	5.390	62	50	63	55
ILHB-450 MV ECOWATT ASR	5133032600	1500	1,24	5,4	7.870	66	55	67	72
Drehstrom 3~ 400V, 50/60 Hz, EC-Motor									
ILHT-500 MV ECOWATT ASR	5133032700	1500	1,70	3,5	9.790	68	58	70	94
ILHT-630 MV ECOWATT ASR	5133032800	1130	3,16	7,0	13.060	68	59	69	132
ILHT-710 MV ECOWATT ASR	5133032900	1250	5,91	12,4	25.150	73	68	77	158

ABMESSUNGEN (MM)

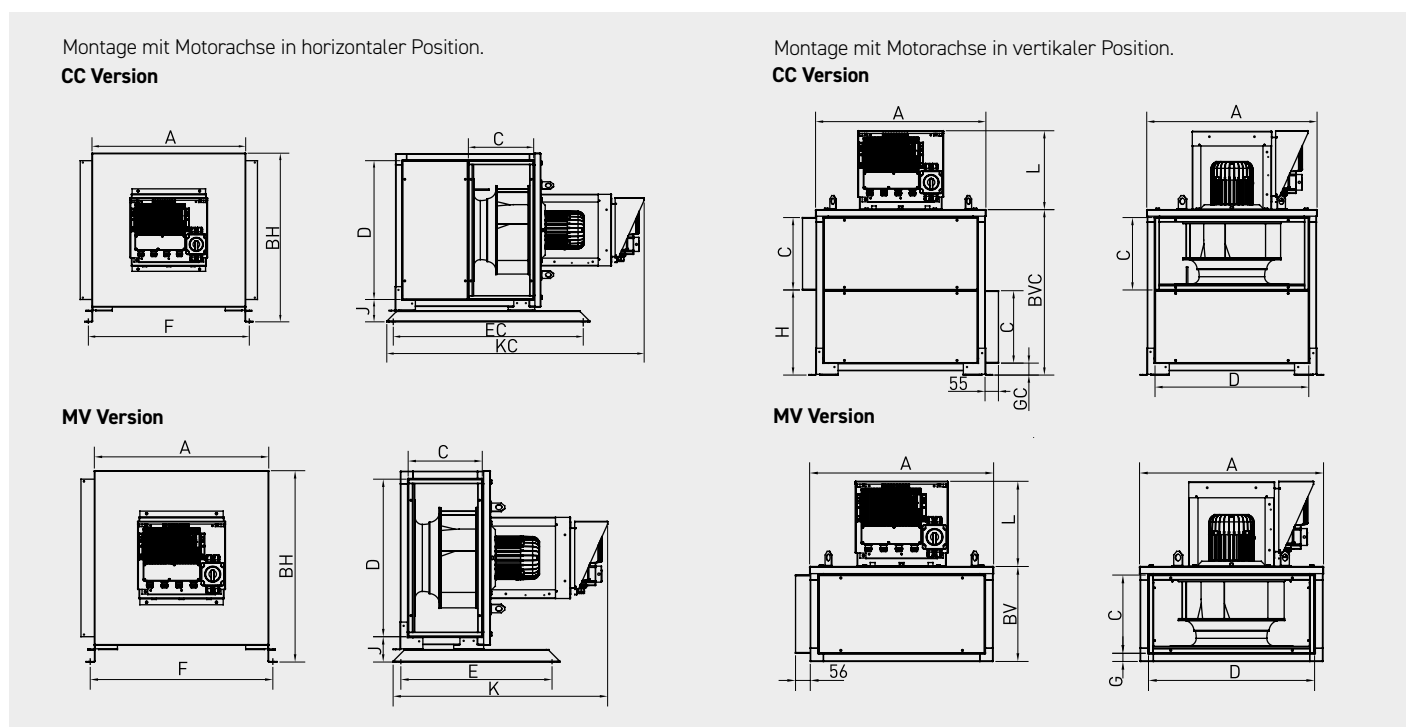

MODEL	A	BH	BV	BVC	C	D	E	EC	F	G	GC	H	J	K	KC	L
355	627	695	327	645	263	559	606	790	660	31	50	315	102	826	1103	321
400	699	767	361	678	297	631	606	864	732	31	50	349	102	860	1170	321
450	779	847	392	738	326	711	606	990	812	31	50	378	102	892	1230	321
500	858	925	424	784	338	768	700	1039	890	42	62	402	112	954	1294	351
630	1066	1133	488	912	403	977	700	1183	1098	42	62	466	112	1018	1422	351
710	1194	1261	551	1032	462	1104	906	1325	1226	42	62	526	112	1070	1533	446

LEISTUNGSKURVEN - AKUSTISCHE EIGENSCHAFTEN

- q_v : Volumenstrom in m^3/h
- p_{sf} : Statischer Druck in Pa
- P: Eingangsleistung in W

- SFP: Specific fan power in $W/m^3/s$ (blaue Kurven)
- Leistungsdaten gemäß ISO 5801 und AMCA 210-99 Standards
- Schallleistungsspektrum (dB(A))

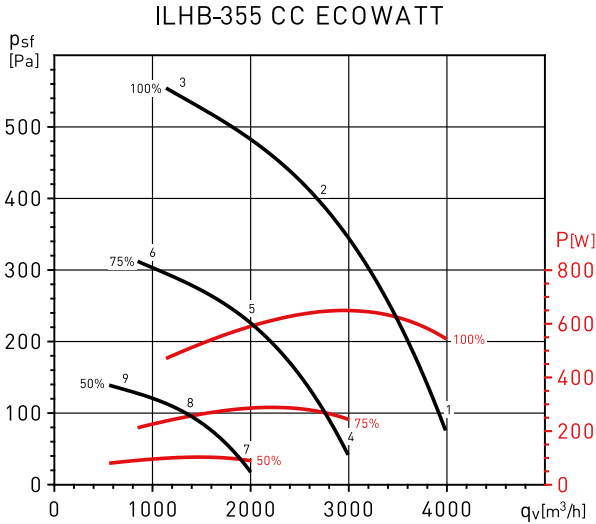

ILHB-355 CC ECOWATT		63	125	250	500	1000	2000	4000	8000	LWA	
100%	L _{WA} Saugseitig	1	55	76	70	71	73	72	68	59	80
		2	51	71	65	68	71	70	65	57	77
		3	59	69	64	67	68	66	62	54	74
	L _{WA} Druckseitig	1	51	79	78	77	80	77	72	64	86
		2	47	75	74	74	78	74	68	62	83
		3	54	72	74	73	75	71	64	58	80
75%	L _{WA} Saugseitig	1	55	69	66	62	65	63	59	51	73
		2	51	65	61	58	63	61	56	50	70
		3	59	62	60	58	60	57	53	46	68
	L _{WA} Druckseitig	4	49	69	64	65	67	66	62	53	74
		5	45	65	59	62	65	64	59	51	71
		6	52	62	58	61	62	60	55	48	68
50%	L _{WA} Saugseitig	4	45	73	72	71	74	71	66	58	79
		5	41	69	68	68	72	68	62	55	76
		6	48	66	68	67	69	65	58	51	74
	L _{WA} Druckseitig	4	49	63	60	56	59	57	53	45	67
		5	45	59	55	52	57	55	50	43	63
		6	53	56	54	51	53	51	47	40	61
50%	L _{WA} Saugseitig	7	40	60	55	56	58	57	53	44	65
		8	36	56	50	53	56	55	50	42	62
		9	44	54	49	52	53	51	47	39	59
	L _{WA} Druckseitig	7	36	64	63	62	65	62	57	49	71
		8	32	60	59	59	63	59	53	47	68
		9	39	57	59	58	60	56	49	43	65
L _{WA} Abstrahlung	7	40	54	51	47	50	48	44	36	58	
	8	36	50	46	43	48	46	41	35	54	
	9	44	47	45	43	45	42	38	31	53	

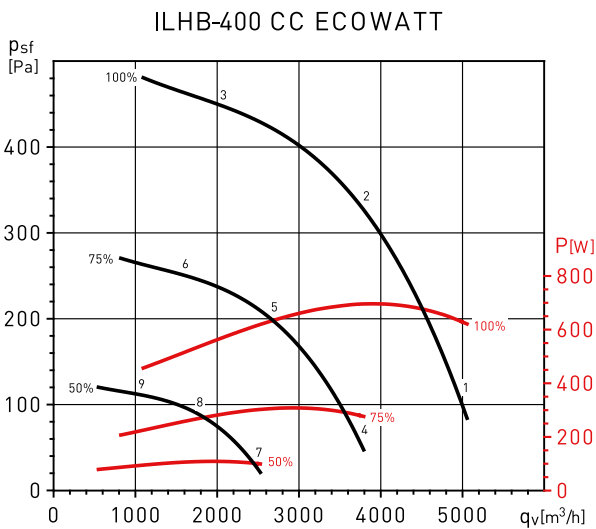

ILHB-400 CC ECOWATT		63	125	250	500	1000	2000	4000	8000	LWA	
100%	L _{WA} Saugseitig	1	57	72	71	72	72	73	68	60	79
		2	50	69	66	67	69	70	64	57	76
		3	56	67	63	66	67	66	61	56	73
	L _{WA} Druckseitig	1	53	76	80	79	81	77	73	66	86
		2	48	73	74	74	76	74	69	62	82
		3	54	70	73	73	75	70	63	57	80
75%	L _{WA} Saugseitig	1	54	65	67	61	63	65	58	51	72
		2	48	61	62	56	59	61	55	49	68
		3	54	59	59	56	58	58	51	48	66
	L _{WA} Druckseitig	4	50	66	64	65	66	67	62	54	73
		5	44	63	59	61	62	63	58	51	69
		6	50	61	57	60	60	60	55	50	67
50%	L _{WA} Saugseitig	4	47	70	73	72	75	71	66	59	80
		5	42	67	68	68	70	67	62	56	75
		6	47	63	67	67	68	64	57	51	73
	L _{WA} Druckseitig	4	48	59	61	55	57	58	52	45	66
		5	42	55	56	50	53	55	49	42	62
		6	47	53	53	49	51	51	45	42	59
50%	L _{WA} Saugseitig	7	41	57	55	56	57	58	53	45	64
		8	35	54	51	52	53	55	49	42	60
		9	41	52	48	51	52	51	46	41	58
	L _{WA} Druckseitig	7	38	61	64	63	66	62	57	50	71
		8	33	58	59	59	61	58	53	47	66
		9	38	54	58	58	59	55	48	42	65
L _{WA} Abstrahlung	7	39	50	52	46	48	50	43	36	57	
	8	33	46	47	41	44	46	40	33	53	
	9	39	44	44	41	42	42	36	33	50	

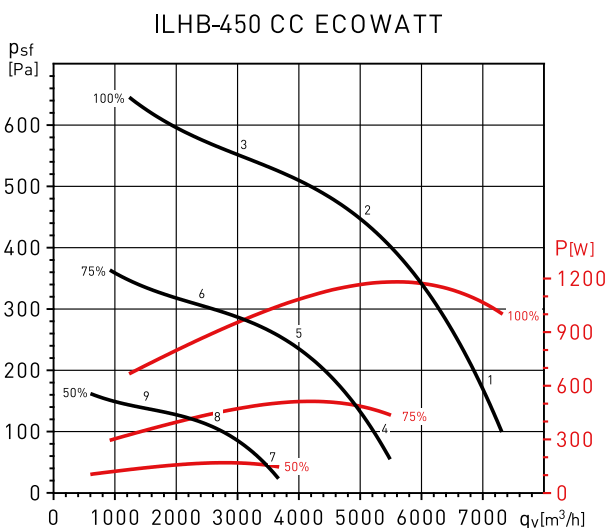

ILHB-450 CC ECOWATT		63	125	250	500	1000	2000	4000	8000	LWA	
100%	L _{WA} Saugseitig	1	60	76	75	76	76	76	72	65	83
		2	56	70	73	73	74	74	69	64	80
		3	60	70	70	72	71	71	67	63	78
	L _{WA} Druckseitig	1	62	78	85	85	87	82	78	71	91
		2	57	74	80	80	82	78	72	66	87
		3	60	72	78	78	80	74	67	61	84
75%	L _{WA} Saugseitig	1	55	69	71	68	69	68	64	57	76
		2	50	63	69	65	67	65	60	55	73
		3	54	63	66	64	64	62	59	54	71
	L _{WA} Druckseitig	4	54	69	69	70	70	70	66	59	77
		5	49	64	67	67	67	68	63	58	74
		6	53	63	64	65	64	64	61	56	72
50%	L _{WA} Saugseitig	4	56	72	79	78	80	76	71	64	85
		5	51	68	74	74	76	71	66	60	80
		6	54	66	72	72	73	68	61	55	78
	L _{WA} Druckseitig	4	49	62	65	62	63	62	57	51	70
		5	44	57	63	59	60	59	54	49	67
		6	48	57	60	58	57	56	53	48	65
50%	L _{WA} Saugseitig	7	45	60	60	61	61	61	57	50	68
		8	40	55	58	58	58	59	54	49	65
		9	44	55	55	57	56	55	52	47	63
	L _{WA} Druckseitig	7	47	63	70	69	71	67	63	56	76
		8	42	59	65	65	67	62	57	51	72
		9	45	57	63	63	65	59	52	46	69
L _{WA} Abstrahlung	7	40	54	56	53	54	53	48	42	61	
	8	35	48	54	50	51	50	45	40	58	
	9	39	48	51	49	48	47	44	39	56	

LEISTUNGSKURVEN - AKUSTISCHE EIGENSCHAFTEN

- q_v : Volumenstrom in m^3/h
- p_{sf} : Statischer Druck in Pa
- P: Eingangsleistung in W

- SFP: Specific fan power in $W/m^3/s$ (blaue Kurven)
- Leistungsdaten gemäß ISO 5801 und AMCA 210-99 Standards
- Schalleistungsspektrum (dB(A))

ILHT-500 CC ECOWATT

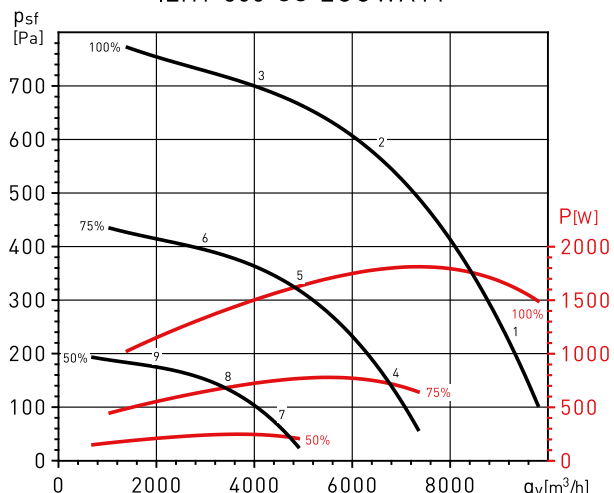

ILHT-500 CC ECOWATT		63	125	250	500	1000	2000	4000	8000	LWA	
100%	L_{WA} Saugseitig	1	64	73	76	77	79	79	74	68	85
		2	63	70	72	74	77	75	70	65	82
		3	65	71	71	73	75	72	67	61	80
	L_{WA} Druckseitig	4	66	81	88	87	90	84	80	72	94
		5	62	76	82	82	86	79	75	68	89
		6	64	75	81	80	83	76	70	63	87
	L_{WA} Abstrahlung	7	54	63	69	66	73	67	62	55	76
		8	52	60	64	62	71	63	58	52	73
		9	54	61	63	61	68	60	55	48	71
75%	L_{WA} Saugseitig	1	58	67	70	71	73	72	67	61	79
		2	56	64	66	68	71	69	64	59	76
		3	59	65	64	66	69	66	61	55	74
	L_{WA} Druckseitig	4	60	75	81	81	83	77	73	66	88
		5	56	70	76	76	80	73	69	62	83
		6	58	69	75	74	77	70	64	57	81
	L_{WA} Abstrahlung	7	48	57	63	60	67	61	55	49	70
		8	46	53	58	56	65	57	51	46	67
		9	48	55	56	55	62	54	48	42	65
50%	L_{WA} Saugseitig	1	49	58	61	62	64	63	58	52	70
		2	48	55	57	59	62	60	55	50	67
		3	50	56	56	58	60	57	52	46	65
	L_{WA} Druckseitig	4	51	66	73	72	75	69	64	57	79
		5	47	61	67	67	71	64	60	53	74
		6	49	60	66	65	68	61	55	48	72
	L_{WA} Abstrahlung	7	39	48	54	51	58	52	46	40	61
		8	37	45	49	47	56	48	43	37	58
		9	39	46	48	46	53	45	40	33	56

ILHT-630 CC ECOWATT

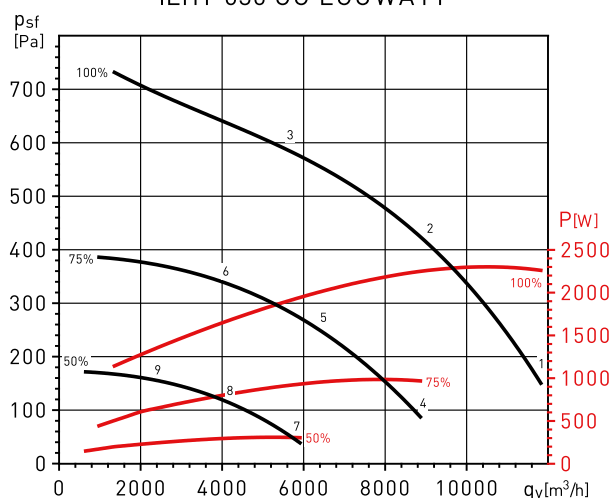

ILHT-630 CC ECOWATT		63	125	250	500	1000	2000	4000	8000	LWA	
100%	L_{WA} Saugseitig	1	68	76	78	77	81	78	72	66	86
		2	63	72	73	74	78	74	69	63	82
		3	67	71	73	73	76	71	66	61	80
	L_{WA} Druckseitig	1	68	79	82	83	85	79	74	68	90
		2	65	75	78	79	82	77	71	65	86
		3	68	75	78	79	80	73	68	61	85
	L_{WA} Abstrahlung	1	61	72	68	67	70	67	60	55	76
		2	56	68	63	63	67	64	57	52	73
		3	61	67	62	63	65	60	53	49	71
75%	L_{WA} Saugseitig	4	61	70	72	71	74	72	66	60	80
		5	56	66	67	67	72	68	63	57	76
		6	61	65	67	67	70	65	59	55	74
	L_{WA} Druckseitig	4	62	73	76	77	79	73	68	61	83
		5	59	69	72	73	76	70	65	59	80
		6	61	69	72	73	74	67	61	55	79
	L_{WA} Abstrahlung	4	55	66	62	61	64	61	54	48	70
		5	50	62	57	57	61	57	51	45	67
		6	55	61	56	56	59	54	47	43	65
50%	L_{WA} Saugseitig	7	52	61	63	62	66	63	57	51	71
		8	47	57	58	59	63	59	54	48	67
		9	52	56	58	58	61	56	50	46	65
	L_{WA} Druckseitig	7	53	64	67	68	70	64	59	52	75
		8	50	60	63	64	67	62	56	50	71
		9	52	60	63	64	65	58	52	46	70
	L_{WA} Abstrahlung	7	46	57	53	52	55	52	45	39	61
		8	41	53	48	48	52	49	42	37	58
		9	46	52	47	47	50	45	38	34	56

ILHT-710 CC ECOWATT

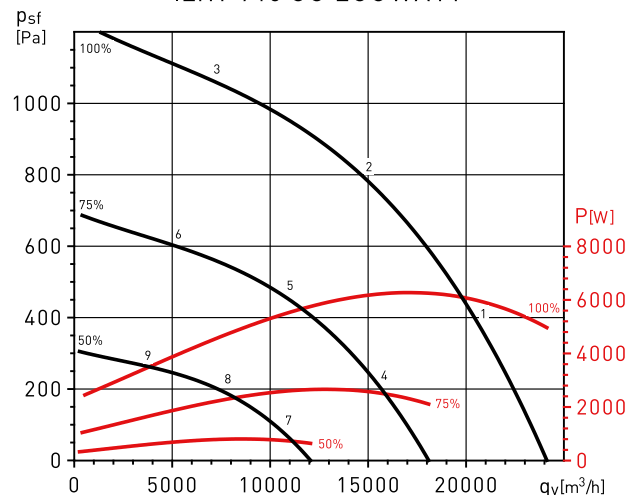

ILHT-710 CC ECOWATT		63	125	250	500	1000	2000	4000	8000	LWA	
100%	L_{WA} Saugseitig	1	75	81	82	83	85	82	75	69	90
		2	74	78	81	81	82	79	73	70	88
		3	75	75	79	80	81	77	73	70	87
	L_{WA} Druckseitig	1	75	90	92	94	94	88	80	73	99
		2	72	84	86	88	88	82	75	70	93
		3	75	83	86	88	87	79	73	68	93
	L_{WA} Abstrahlung	1	64	77	74	79	75	69	59	54	83
		2	63	74	72	77	72	66	58	54	81
		3	64	71	71	76	71	64	58	54	79
75%	L_{WA} Saugseitig	4	69	75	76	77	79	75	69	63	84
		5	68	72	74	75	76	73	67	63	82
		6	69	69	73	74	75	71	67	64	80
	L_{WA} Druckseitig	4	69	84	86	88	88	81	74	67	93
		5	65	78	80	82	82	76	69	64	87
		6	69	77	80	82	80	73	67	62	87
	L_{WA} Abstrahlung	4	58	71	68	73	69	62	53	47	77
		5	57	67	66	71	66	59	52	48	74
		6	58	65	65	70	65	58	52	48	73
50%	L_{WA} Saugseitig	7	60	66	67	68	70	67	60	54	75
		8	59	63	66	66	67	64	58	55	73
		9	60	60	64	65	66	62	58	55	72
	L_{WA} Druckseitig	7	60	75	77	79	79	73	65	58	84
		8	57	69	71	73	73	67	60	55	78
		9	60	68	71	73	72	64	58	53	78
	L_{WA} Abstrahlung	7	49	62	59	64	60	53	44	39	68
		8	48	59	57	62	57	51	43	39	65
		9	49	56	56	61	56	49	43	39	64

LEISTUNGSKURVEN - AKUSTISCHE EIGENSCHAFTEN

- q_v : Volumenstrom in m^3/h
- p_{sf} : Statischer Druck in Pa
- P: Eingangsleistung in W

- SFP: Specific fan power in $W/m^3/s$ (blaue Kurven)
- Leistungsdaten gemäß ISO 5801 und AMCA 210-99 Standards
- Schallleistungsspektrum (dB(A))

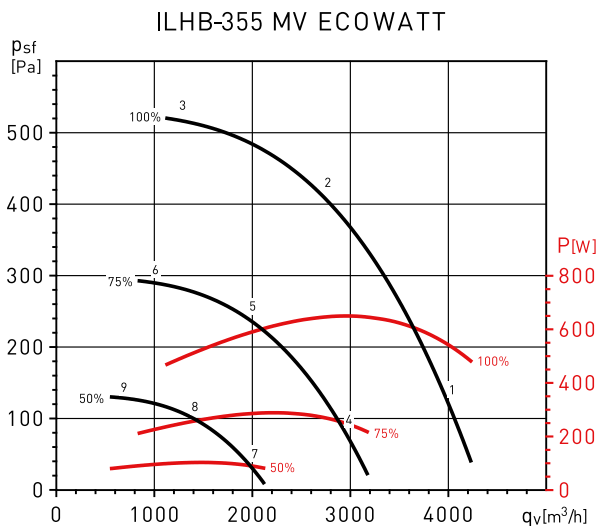

ILHB-355 MV ECOWATT		63	125	250	500	1000	2000	4000	8000	LWA	
100%	L _{WA} Saugseitig	1	48	73	71	67	71	73	69	64	79
		2	46	70	67	65	71	69	66	62	77
		3	57	71	70	67	70	67	63	58	77
	L _{WA} Druckseitig	1	47	72	74	73	74	74	70	64	81
		2	45	70	72	70	72	71	66	60	78
		3	56	71	73	72	71	69	62	56	79
L _{WA} Abstrahlung	1	48	61	58	57	60	63	60	57	68	
	2	47	58	55	55	59	60	56	55	66	
	3	57	59	58	57	59	57	53	51	66	
75%	L _{WA} Saugseitig	4	41	67	64	60	65	67	63	58	73
		5	40	64	61	58	65	63	60	56	70
		6	51	65	64	60	64	60	56	52	71
	L _{WA} Druckseitig	4	41	66	68	66	68	68	64	58	75
		5	39	64	66	64	66	65	60	54	72
		6	50	65	67	66	65	63	56	50	72
L _{WA} Abstrahlung	4	42	54	52	51	54	57	54	51	62	
	5	41	52	48	49	53	54	50	49	60	
	6	51	53	52	51	52	51	47	45	60	
50%	L _{WA} Saugseitig	7	33	58	55	52	56	58	54	49	64
		8	31	55	52	50	56	54	51	47	61
		9	42	56	55	52	55	52	48	43	62
	L _{WA} Druckseitig	7	32	57	59	57	59	59	55	49	66
		8	30	55	57	55	57	56	51	45	63
		9	41	56	58	57	56	54	47	41	64
L _{WA} Abstrahlung	7	33	46	43	42	45	48	45	42	53	
	8	32	43	40	40	44	45	41	40	51	
	9	42	44	43	42	44	42	38	36	51	

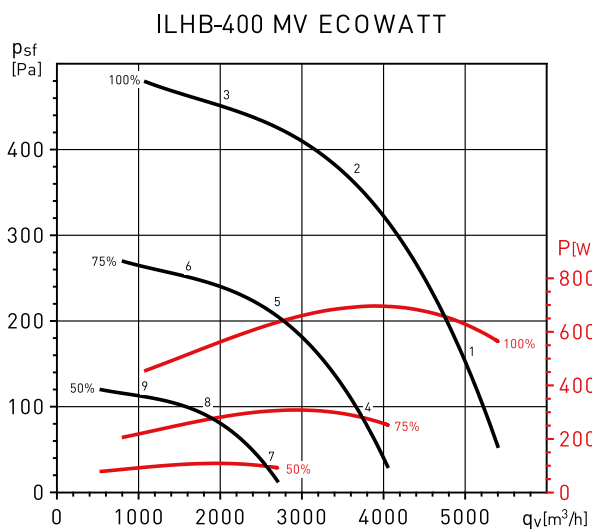

ILHB-400 MV ECOWATT		63	125	250	500	1000	2000	4000	8000	LWA	
100%	L _{WA} Saugseitig	1	46	76	72	66	70	72	68	65	80
		2	43	73	68	64	68	69	65	60	77
		3	54	72	69	65	67	67	63	58	76
	L _{WA} Druckseitig	1	48	71	73	73	75	74	70	64	81
		2	44	68	70	69	72	70	67	60	77
		3	55	70	72	70	72	68	62	55	78
L _{WA} Abstrahlung	1	43	63	61	56	59	59	54	48	68	
	2	40	59	57	53	57	57	52	43	64	
	3	51	59	58	55	56	54	49	42	64	
75%	L _{WA} Saugseitig	4	40	70	66	60	64	65	62	58	74
		5	37	66	62	57	62	63	59	54	70
		6	48	65	63	59	61	60	57	52	70
	L _{WA} Druckseitig	4	41	65	67	66	69	68	64	58	75
		5	37	62	63	63	65	64	60	54	71
		6	49	63	66	64	65	62	56	48	71
L _{WA} Abstrahlung	4	37	57	55	50	53	53	48	42	61	
	5	34	53	51	47	51	51	45	37	58	
	6	45	52	52	48	50	48	43	35	58	
50%	L _{WA} Saugseitig	7	31	61	57	51	55	56	53	49	65
		8	28	57	53	48	53	54	50	45	61
		9	39	57	54	50	52	51	48	43	61
	L _{WA} Druckseitig	7	32	56	58	57	60	59	55	49	66
		8	28	53	55	54	56	55	51	45	62
		9	40	55	57	55	56	53	47	39	62
L _{WA} Abstrahlung	7	28	48	46	41	44	44	39	33	53	
	8	25	44	42	38	42	42	36	28	49	
	9	36	43	43	40	41	39	34	27	49	

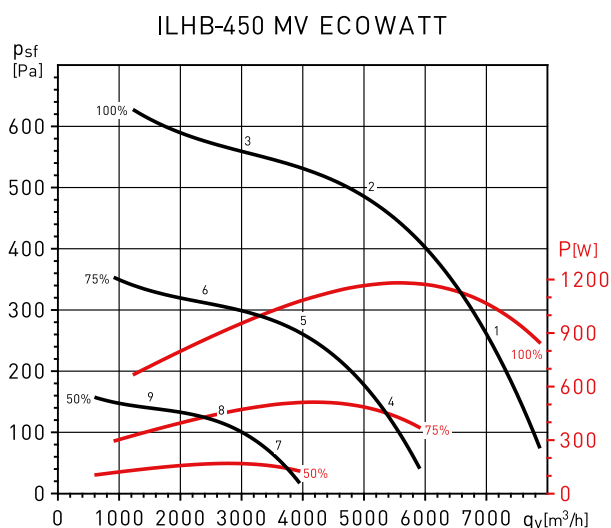

ILHB-450 MV ECOWATT		63	125	250	500	1000	2000	4000	8000	LWA	
100%	L _{WA} Saugseitig	1	53	77	74	70	76	75	72	67	82
		2	51	75	71	69	74	73	70	65	80
		3	62	75	73	70	73	70	66	61	80
	L _{WA} Druckseitig	1	53	76	78	76	78	77	74	69	85
		2	50	73	74	74	76	75	71	66	82
		3	58	73	76	75	76	72	67	61	82
L _{WA} Abstrahlung	1	50	68	62	59	64	64	62	53	72	
	2	49	65	59	58	62	62	60	51	70	
	3	59	66	61	59	62	59	56	47	70	
75%	L _{WA} Saugseitig	4	46	71	68	64	69	69	66	61	76
		5	45	68	65	63	68	67	63	59	74
		6	55	69	66	64	67	64	59	55	74
	L _{WA} Druckseitig	4	47	69	71	70	72	71	67	63	78
		5	44	67	68	67	70	69	64	59	76
		6	51	67	70	68	70	66	60	55	76
L _{WA} Abstrahlung	4	44	62	56	53	58	58	56	47	66	
	5	42	59	53	51	56	56	53	45	64	
	6	53	60	55	53	55	53	50	41	63	
50%	L _{WA} Saugseitig	7	37	62	59	55	60	60	57	52	67
		8	36	59	56	54	59	58	54	50	65
		9	46	60	57	55	58	55	51	46	65
	L _{WA} Druckseitig	7	38	60	62	61	63	62	59	54	69
		8	35	58	59	58	61	60	55	50	67
		9	42	58	61	59	61	57	51	46	67
L _{WA} Abstrahlung	7	35	53	47	44	49	49	47	38	57	
	8	33	50	44	43	47	47	44	36	55	
	9	44	51	46	44	46	44	41	32	55	

LEISTUNGSKURVEN - AKUSTISCHE EIGENSCHAFTEN

- q_v : Volumenstrom in m^3/h
- p_{sf} : Statischer Druck in Pa
- P: Eingangsleistung in W

- SFP: Specific fan power in $W/m^3/s$ (blaue Kurven)
- Leistungsdaten gemäß ISO 5801 und AMCA 210-99 Standards
- Schalleistungsspektrum (dB(A))

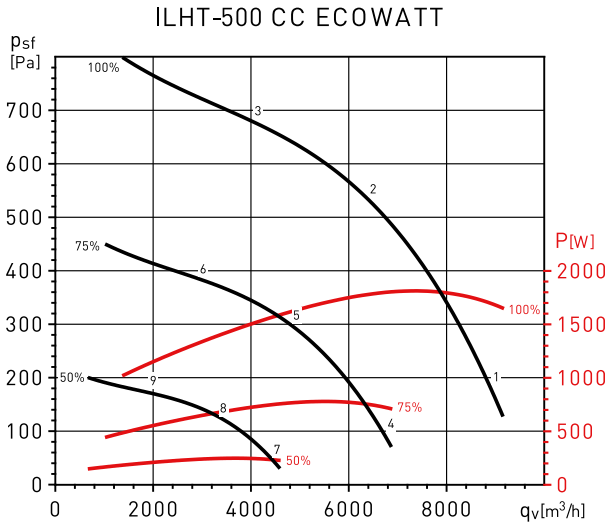

ILHT-500 CC ECOWATT		63	125	250	500	1000	2000	4000	8000	LWA	
100%	L _{WA} Saugseitig	1	64	73	76	77	79	79	74	68	85
		2	63	70	72	74	77	75	70	65	82
		3	65	71	71	73	75	72	67	61	80
	L _{WA} Druckseitig	1	66	81	88	87	90	84	80	72	94
		2	62	76	82	82	86	79	75	68	89
		3	64	75	81	80	83	76	70	63	87
L _{WA} Abstrahlung	1	54	63	69	66	73	67	62	55	76	
	2	52	60	64	62	71	63	58	52	73	
	3	54	61	63	61	68	60	55	48	71	
75%	L _{WA} Saugseitig	4	58	67	70	71	73	72	67	61	79
		5	56	64	66	68	71	69	64	59	76
		6	59	65	64	66	69	66	61	55	74
	L _{WA} Druckseitig	4	60	75	81	81	83	77	73	66	88
		5	56	70	76	76	80	73	69	62	83
		6	58	69	75	74	77	70	64	57	81
L _{WA} Abstrahlung	4	48	57	63	60	67	61	55	49	70	
	5	46	53	58	56	65	57	51	46	67	
	6	48	55	56	55	62	54	48	42	65	
50%	L _{WA} Saugseitig	7	49	58	61	62	64	63	58	52	70
		8	48	55	57	59	62	60	55	50	67
		9	50	56	56	58	60	57	52	46	65
	L _{WA} Druckseitig	7	51	66	73	72	75	69	64	57	79
		8	47	61	67	67	71	64	60	53	74
		9	49	60	66	65	68	61	55	48	72
L _{WA} Abstrahlung	7	39	48	54	51	58	52	46	40	61	
	8	37	45	49	47	56	48	43	37	58	
	9	39	46	48	46	53	45	40	33	56	

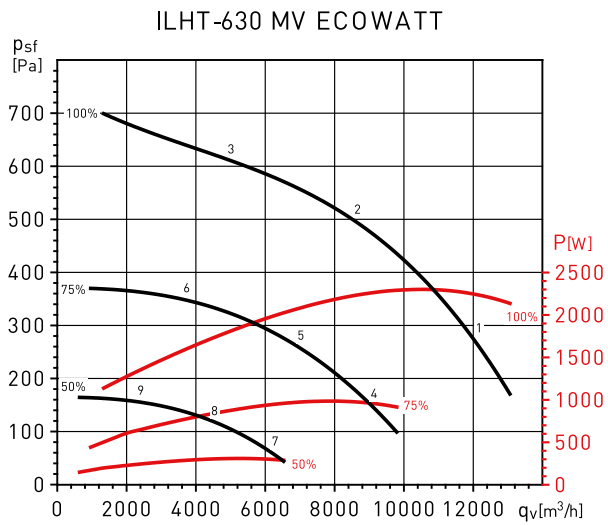

ILHT-630 MV ECOWATT		63	125	250	500	1000	2000	4000	8000	LWA	
100%	L _{WA} Saugseitig	1	57	76	73	72	78	76	72	66	83
		2	60	72	72	71	77	75	72	71	82
		3	67	74	73	71	75	70	67	67	81
	L _{WA} Druckseitig	1	60	73	77	78	80	77	73	67	85
		2	59	72	75	76	79	75	70	65	83
		3	66	72	77	77	78	72	67	65	84
L _{WA} Abstrahlung	1	49	65	64	65	68	67	65	62	74	
	2	51	62	64	64	68	66	64	67	74	
	3	58	64	65	64	65	62	59	63	72	
75%	L _{WA} Saugseitig	4	51	69	67	66	72	70	66	60	77
		5	54	66	66	65	71	69	66	65	76
		6	60	68	67	65	69	64	61	61	75
	L _{WA} Druckseitig	4	54	67	71	72	74	71	67	61	79
		5	53	65	69	70	73	69	64	58	77
		6	60	66	71	71	72	65	60	59	77
L _{WA} Abstrahlung	4	43	59	58	58	62	61	58	56	68	
	5	45	56	57	58	61	60	58	61	68	
	6	52	58	59	58	59	55	53	57	66	
50%	L _{WA} Saugseitig	7	42	61	58	57	63	61	57	51	68
		8	45	57	57	56	62	60	57	56	67
		9	51	59	58	56	60	55	52	52	66
	L _{WA} Druckseitig	7	45	58	62	63	65	62	58	52	70
		8	44	57	60	61	64	60	55	49	68
		9	51	57	62	62	63	57	51	50	68
L _{WA} Abstrahlung	7	34	50	49	49	53	52	49	47	59	
	8	36	47	48	49	52	51	49	52	59	
	9	43	49	50	49	50	47	44	48	57	

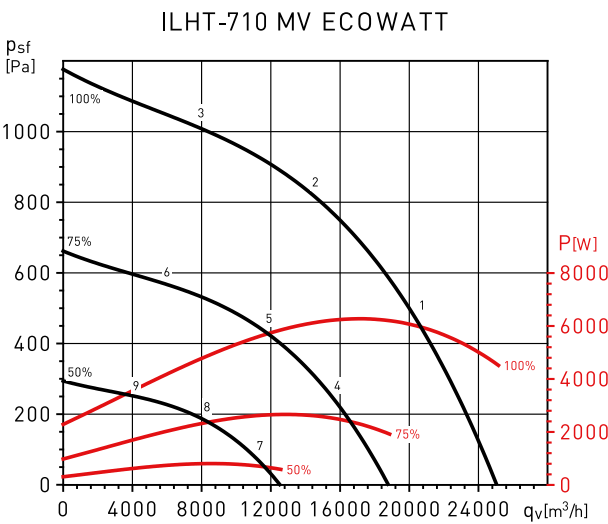

ILHT-710 MV ECOWATT		63	125	250	500	1000	2000	4000	8000	LWA	
100%	L _{WA} Saugseitig	1	65	81	77	82	85	82	76	71	89
		2	70	82	80	82	81	77	72	67	88
		3	74	80	78	82	81	78	73	69	88
	L _{WA} Druckseitig	1	72	83	86	89	88	84	79	75	94
		2	67	79	84	88	86	81	76	73	92
		3	74	79	86	88	86	79	75	73	92
L _{WA} Abstrahlung	1	59	76	71	78	80	76	72	67	84	
	2	64	76	74	78	76	70	67	63	83	
	3	69	75	72	79	76	71	68	65	83	
75%	L _{WA} Saugseitig	4	58	75	71	76	79	76	70	65	83
		5	64	75	74	76	75	71	65	61	82
		6	68	74	72	76	75	72	67	62	82
	L _{WA} Druckseitig	4	66	77	80	83	82	78	72	69	88
		5	61	73	78	82	80	75	70	67	86
		6	67	73	79	82	79	73	69	67	86
L _{WA} Abstrahlung	4	53	70	65	72	74	70	65	61	78	
	5	58	70	68	72	70	64	61	57	77	
	6	62	69	66	72	70	65	62	58	77	
50%	L _{WA} Saugseitig	7	49	66	62	67	70	67	61	56	74
		8	55	67	65	67	66	62	57	52	73
		9	59	65	63	67	66	63	58	53	73
	L _{WA} Druckseitig	7	57	68	71	74	73	69	64	60	79
		8	52	64	69	73	71	66	61	58	77
		9	59	64	71	73	71	64	60	58	77
L _{WA} Abstrahlung	7	44	61	56	63	65	61	56	52	69	
	8	49	61	59	63	61	55	52	48	68	
	9	54	60	57	64	61	56	53	49	68	

MONTAGE ZUBEHÖR

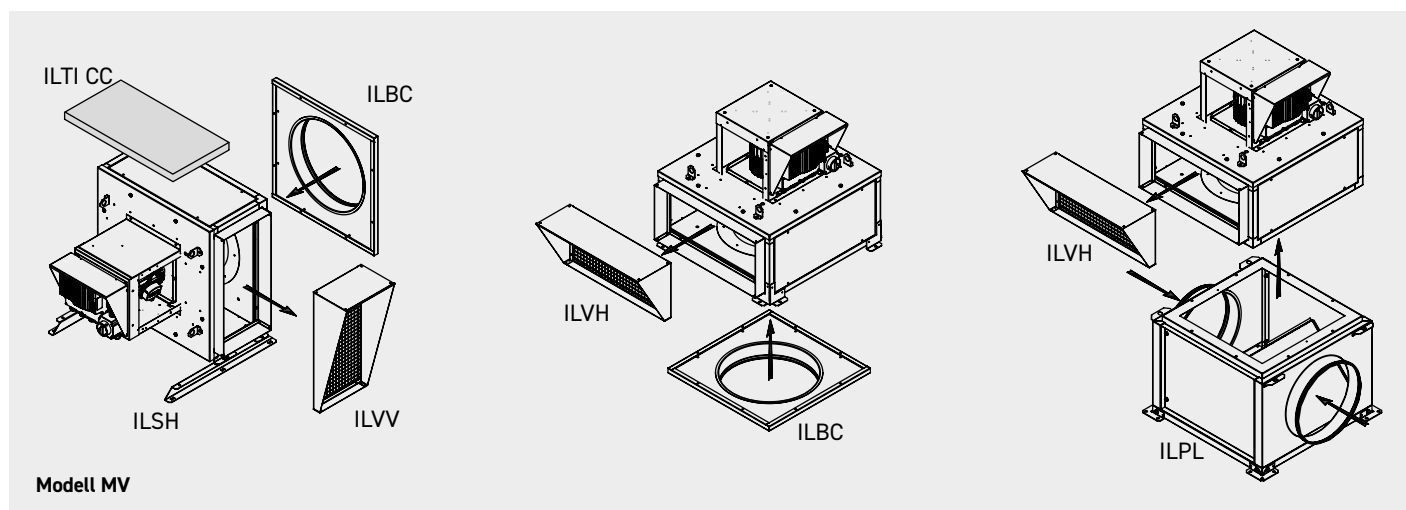
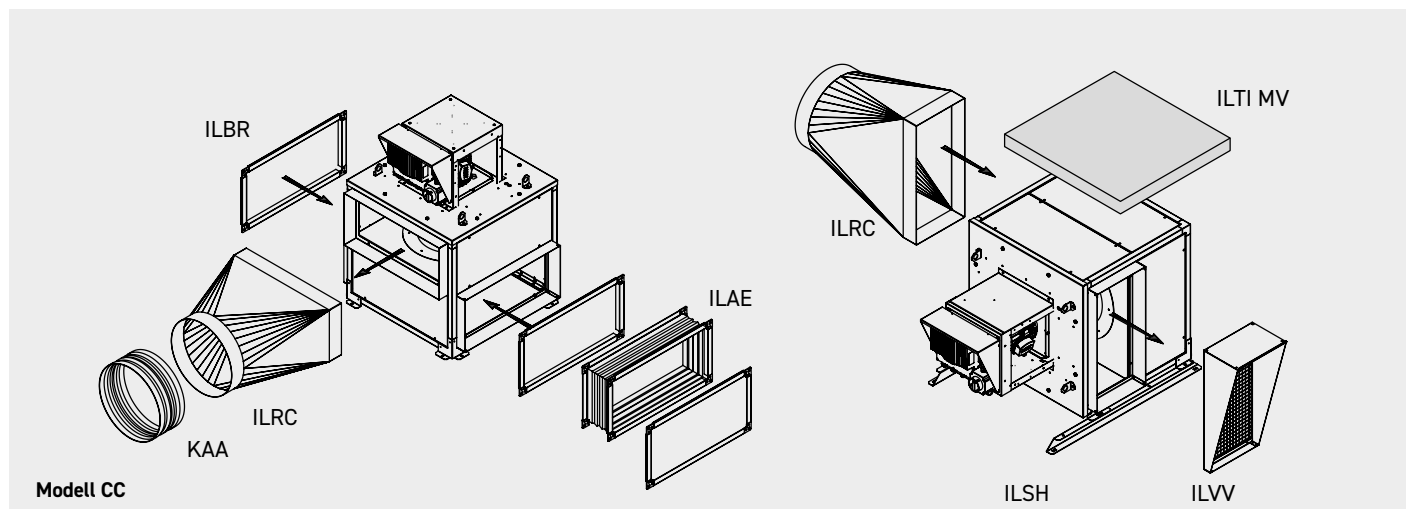

Modell	Gegenflansch	Elastische Verbindung	Ausblasstutzen		Anschlussplatte, rund	Sammelkasten	Montagekonsolen	Wetterschutzdach*	Übergangsstück auf rund
			horizontal	vertikal					
ILHB-355 CC ECOWATT	ILBR-355	ILAE-355	ILVH-355	ILVV-355	-	-	ILSH-355 CC	ILTI-355 CC	ILRC-355
ILHB-400 CC ECOWATT	ILBR-400	ILAE-400	ILVH-400	ILVV-400	-	-	ILSH-400 CC	ILTI-400 CC	ILRC-400
ILHB-450 CC ECOWATT	ILBR-450	ILAE-450	ILVH-450	ILVV-450	-	-	ILSH-450 CC	ILTI-450 CC	ILRC-450
ILHT-500 CC ECOWATT	ILBR-500	ILAE-500	ILVH-500	ILVV-500	-	-	ILSH-500 CC	ILTI-500 CC	ILRC-500
ILHT-630 CC ECOWATT	ILBR-630	ILAE-630	ILVH-630	ILVV-630	-	-	ILSH-630 CC	ILTI-630 CC	ILRC-630
ILHT-710 CC ECOWATT	ILBR-710	ILAE-710	ILVH-710	ILVV-710	-	-	ILSH-710 CC	ILTI-710 CC	ILRC-710

ILHB-355 MV ECOWATT	ILBR-355	ILAE-355	ILVH-355	ILVV-355	ILBC-355	ILRC-355	ILSH-355 MV	ILTI-355 MV	ILRC-355
ILHB-400 MV ECOWATT	ILBR-400	ILAE-400	ILVH-400	ILVV-400	ILBC-400	ILRC-400	ILSH-400 MV	ILTI-400 MV	ILRC-400
ILHB-450 MV ECOWATT	ILBR-450	ILAE-450	ILVH-450	ILVV-450	ILBC-450	ILRC-450	ILSH-450 MV	ILTI-450 MV	ILRC-450
ILHT-500 MV ECOWATT	ILBR-500	ILAE-500	ILVH-500	ILVV-500	ILBC-500	ILRC-500	ILSH-500 MV	ILTI-500 MV	ILRC-500
ILHT-630 MV ECOWATT	ILBR-630	ILAE-630	ILVH-630	ILVV-630	ILBC-630	ILRC-630	ILSH-630 MV	ILTI-630 MV	ILRC-630
ILHT-710 MV ECOWATT	ILBR-710	ILAE-710	ILVH-710	ILVV-710	ILBC-710	ILRC-710	ILSH-710 MV	ILTI-710 MV	ILRC-710

* Nur bei Aufstellung mit horizontaler Motorachse notwendig,



ILBR
Kanalseite mit 30 mm Normflansch

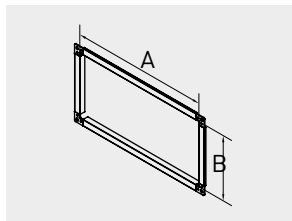

Modell	Artikel Nr.	A	B
ILBR-355	5133753700	559	263
ILBR-400	5133753800	631	297
ILBR-450	5133753900	711	326
ILBR-500	5133754000	768	338
ILBR-630	5133754200	977	403
ILBR-710	5133754300	1104	462



ILAE
Zur Reduzierung von Körperschall

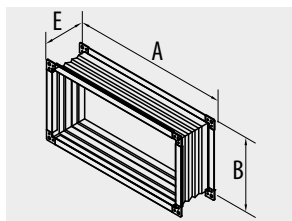

Modell	Artikel Nr.	A	B	E
ILAE-355	0124700036	559	266	160
ILAE-400	0124700037	631	300	160
ILAE-450	0124700038	711	329	160
ILAE-500	0124700039	768	341	160
ILAE-630	0124700040	977	406	160
ILAE-710	0124700041	1104	465	160



ILVH / ILVV
Ausblasstützen 45° für
ILHB / ILHT ECOWATT
mit Vogelschutzgitter
Stahlblech, verzinkt

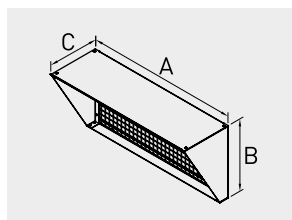

Modell	Artikel Nr.	A	B	C
ILVH-355	5133757700	559	263	197
ILVH-400	5133757800	631	297	216
ILVH-450	5133757900	711	326	233
ILVH-500	5133758000	768	338	240
ILVH-630	5133758200	977	403	278
ILVH-710	5133758300	1104	462	311

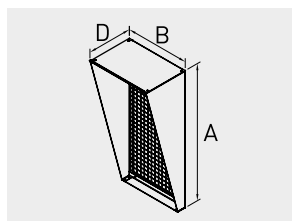

Modell	Artikel Nr.	A	B	D
ILVV-355	5133756900	559	263	194
ILVV-400	5133757000	631	297	213
ILVV-450	5133757100	711	326	234
ILVV-500	5133757200	768	338	249
ILVV-630	5133757400	977	403	305
ILVV-710	5133757500	1104	462	340
ILVV-710	5133757500			



ILBC
Anschlussplatte mit rundem Anschluss
Für MV Modelle
Stahlblech, verzinkt

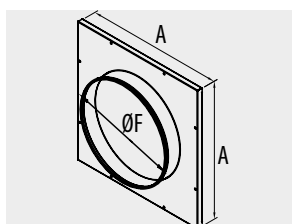

Modell	Artikel Nr.	A	F
ILPL-355	5133758500	559	400
ILPL-400	5133758600	631	450
ILPL-450	5133758700	711	500
ILPL-500	5133758800	768	560
ILPL-630	5133759000	977	710
ILPL-710	5133759100	1104	800

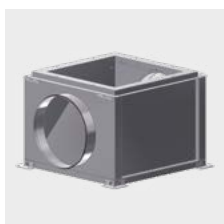

ILPL
Sammelkasten mit zwei runden
Anschlüssen
Für MV Modelle
Stahlblech, verzinkt

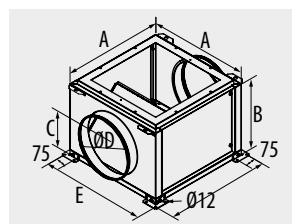

Modell	Artikel Nr.	A	B	C	D	E	Kg
ILPL-355	5133758500	622	448	238	355	662	21
ILPL-400	5133758600	694	498	260	400	734	25
ILPL-450	5133758700	774	555	289	450	814	30
ILPL-500	5133758800	852	675	349	560	892	37
ILPL-630	5133759000	1060	805	441	630	1100	81
ILPL-710	5133759100	1188	885	481	710	1228	99



ILSH MV - ILSH CC
Montagekonsolen,
für Aufstellung in horizontaler Achslage.
Schrauben im Lieferumfang.
Stahlblech, verzinkt

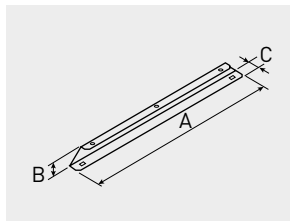

Modell	MV			CC		
	A	B	C	A	B	C
355	668	50	35	848	50	35
400	668	50	35	823	50	35
450	668	50	35	1048	50	35
500	762	50	35	1097	50	35
560	762	50	35	1197	50	35
630	855	50	35	1242	50	35
710	977	50	35	1401	50	35

Modell	Artikel Nr.	Modell	Artikel Nr.
ILSH-355 CC	5133752100	ILSH-355 MV	5133752900
ILSH-400 CC	5133752200	ILSH-400 MV	5133753000
ILSH-450 CC	5133752300	ILSH-450 MV	5133753100
ILSH-500 CC	5133752400	ILSH-500 MV	5133753200
ILSH-630 CC	5133752600	ILSH-630 MV	5133753400
ILSH-710 CC	5133752700	ILSH-710 MV	5133753500



ILTI MV - ILTI CC
Wetterschutzdach
Wetterschutzdach für Ausstellung in
horizontaler Achslage
Stahlblech, verzinkt
Für Standardaufstellung wird kein
zusätzliches Dach benötigt.

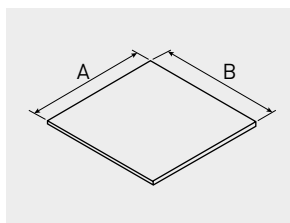

Modell	MV		CC	
	A	B	A	B
355	658	391	658	636
400	731	425	731	721
450	812	453	812	790
500	890	485	890	828
560	985	504	985	859
630	1098	550	1098	953
710	1226	610	1226	1112

Modell	Artikel Nr.	Modell	Artikel Nr.
ILTI-355 CC	5133863100	ILTI-355 MV	5133863900
ILTI-400 CC	5133863200	ILTI-400 MV	5133864000
ILTI-450 CC	5133863300	ILTI-450 MV	5133864100
ILTI-500 CC	5133863400	ILTI-500 MV	5133864200
ILTI-630 CC	5133863600	ILTI-630 MV	5133864400
ILTI-710 CC	5133863700	ILTI-710 MV	5133864500



ILRC
Zum Anschluss an Normrohre
Stahlblech, verzinkt
ILRC = Zentrisch
ILRC C = Konzentrisch

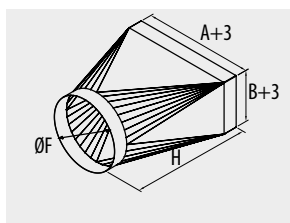

Modell	Artikel Nr.	A	B	F	H
ILRC-355	5133756100	559	266	400	670
ILRC-400	5133756200	631	300	450	670
ILRC-450	5133756300	711	329	500	670
ILRC-500	5133756400	768	341	560	670
ILRC-630	5133756600	977	406	710	670
ILRC-710	5133756700	1104	465	800	670

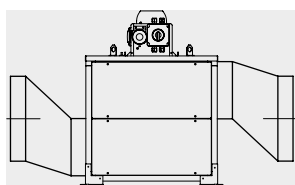

Montagemöglichkeit mit ILRC C

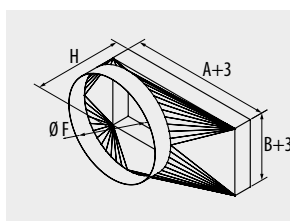

Modell	Artikel Nr.	A	B	F	H
ILRC-355 C	0128000013	559	266	400	670
ILRC-400 C	0128000014	631	300	450	670
ILRC-450 C	0128000015	711	329	500	670
ILRC-500 C	0128000016	768	341	560	670
ILRC-630 C	0128000017	977	406	710	670
ILRC-710 C	0128000018	1104	465	800	670



ILBA
Kanalanschluss ohne Flansch
Im Lieferumfang der ILHB / T sind zwei
Stück enthalten, es können aber
weitere ergänzt werden.
Stahlblech, verzinkt

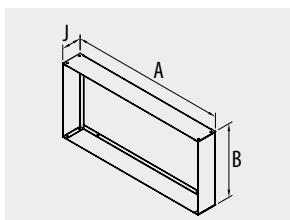

Modell	Artikel Nr.	A	B	J
ILBA 355	0128000020	559	263	80
ILBA 400	0128000021	631	297	80
ILBA 450	0128000022	711	326	80
ILBA 500	0128000023	768	338	80
ILBA 630	0128000024	977	403	80
ILBA 710	0128000025	1104	462	80