



Axial- Rohrventilatoren mit Volumenströmen bis 24.490 m<sup>3</sup>/h,

**Rohrgehäuse** aus Stahlblech, mit beidseitigem Verbindungsflansch. Gesamte Konstruktion mit Epoxid-Polyester-Beschichtung. Klemmenkasten am Gehäuse angebaut

**Axiallaufräder** statisch und dynamisch ausgewuchtet gemäß ISO 1940.

**Baugröße 250, 315, 4-355 und 4-400:**  
- Stahlblech, mit Epoxid-Polyester-Beschichtung

**Alle übrigen Modelle:**

- Aluminiumdruckguss

**AC-Motoren**

Wärmeklasse F, Schutzart IP 65<sup>[1]</sup>, mit separat zum Klemmenbrett geführtem Thermokontakt\* <sup>[1]</sup><sup>[2]</sup>.

Geschlossene Kugellager – wartungsfrei, Motorbemessung Dauerbetrieb S1.

[1] Baugrößen 250, 315, 4-355 und 4-400: Schutzart IP 54, ,mit Thermokontakten ausgestattet; manuelle Rückstellung gemäß EN 60335-2-80

**TCBB**

Spannungsversorgung 1~ 230 V, 50 Hz, TCBT

Spannungsversorgung 3~400 V, 50 Hz.

Baugrößen 4-710 und 800

[2] Schutzart IP 55,

Normmotoren mit Kaltleiter (PTC)

**Weitere Informationen:**

- Luftrichtung -B- (Lauftrad über Motor).
- Alle TCBB Modelle transformatorisch und elektronisch drehzahlsteuerbar (Ausnahmen: Siehe Tabelle **Zubehör Drehzahlreglung**).
- Alle TCBT Modelle transformatorisch und über Frequenzumrichter (20-50 Hz) drehzahlsteuerbar (Ausnahmen: Siehe Tabelle **Zubehör Drehzahlreglung**).
- \*Allpolig wirksamer Motorschutz gemäß EN 60335-2-80 in Verbindung mit einem Motorschutzschalter MSD-2.
- Maximale Fördermitteltemperaturen: Siehe Tabelle **Technische Daten**.
- Die Geräte können in jeder Achslage betrieben werden.



**Korrosionsbeständigkeit**

Rohrgehäuse und Motorträger sind Epoxid-Polyester beschichtet und die Schrauben sind aus Edelstahl.



**Klemmenkasten**

Dichter Anschlussklemmenkasten mit Kabelverschraubung PG-11 (Ausnahme ATEX Modelle).



**Lauftrad**

Statisch und dynamisch ausgewuchtet gemäß ISO 1940, für einen vibrationsfreien Lauf.



**Modelle 4-710 und 800**



**Modelle 250, 315, 4-355 und 4-400**

(Ausnahme 6-355, 6-400 und ATEX Modelle)



**Auf Anfrage Modelle nach ATEX-Richtlinie:**

ATEX Ausführung nur bei Drehstrom Modellen (TCBT) möglich.

Nur für ATEX-Gas (II 2G) in Zündschutzarten:

- Erhöhte Sicherheit
- Ⓜ II 2G Exe II(B) T3 (Drehzahlregelung nicht zulässig, OHNE Thermokontakte, bzw. PTC)

**Weitere Informationen:**

- Luftleistung wie Standardmodelle, Daten vom Motortypenschild können abweichen.
- Maximale Fördermitteltemperaturen: -20°C / +55°C

### TECHNISCHE DATEN

Überprüfen Sie vor der Installation, ob die auf dem Typenschild angegebenen elektrischen Eigenschaften des Produkts (Spannung, Leistung, Frequenz usw.) mit denen der vorgesehenen Stromversorgung übereinstimmen.

Modell	Artikel Nr.	Drehzahl [min <sup>-1</sup> ]	Durchmesser [mm]	Leistungsaufnahme max. [W]	Motorstrom	Schalldruckpegel* [dB(A)]	Volumenstrom (freibl.) [m <sup>3</sup> /h]	Fördermitteltemperaturen [°C]		Gewicht [kg]
					[A] 230 V			Ungeregelt	Geregelt	
Wechselstrom 1~ 230 V, 50 Hz, Kondensatormotor, 2 polig										
TCBB/2-250/H	5705079600	2680	250	123	0,5	62	1.680	-40/+40	-	8,0
Wechselstrom 1~ 230 V, 50 Hz, Kondensatormotor, 4 polig										
TCBB/4-250/H	5705079700	1430	250	44	0,2	42	900	-40/+40	-40/+40	8,0
TCBB/4-315/H	5705079800	1435	315	105	0,6	52	1.990	-40/+40	-40/+40	11,0
TCBB/4-355/H	5705079900	1420	355	120	0,6	52	2.460	-40/+40	-40/+40	13,2
TCBB/4-400/H	5740124200	1410	400	277	1,1	60	5.050	-40/+70	-40/+40	15,5
TCBB/4-450/H	5604636400	1410	450	591	2,5	63	6.940	-40/+70	-	21,0
TCBB/4-500/H	5604636300	1410	500	636	2,8	66	7.500	-40/+70	-40/+50	25,0
TCBB/4-560/L	5604634700	1405	560	1289	6,0	68	11.990	-40/+70	-40/+50	33,0
TCBB/4-560/H	5604634800	1400	560	1308	6,0	69	12.170	-40/+70	-	34,7
TCBB/4-630/L	5604638700	1365	630	1707	7,5	70	15.980	-40/+70	-	40,0
Wechselstrom 1~ 230 V, 50 Hz, Kondensatormotor, 6 polig										
TCBB/6-355/H	5604656800	880	355	92	0,4	46	2.160	-40/+40	-40/+40	13,2
TCBB/6-400/H	5604331800	870	400	118	0,5	48	2.820	-40/+40	-40/+40	15,5
TCBB/6-500/H	5604633200	920	500	226	1,0	57	5.250	-40/+70	-40/+50	24,8
TCBB/6-560/L	5604636500	930	560	375	1,6	60	7.810	-40/+70	-40/+50	33,5
TCBB/6-630/L	5604639600	920	630	514	2,1	60	10.410	-40/+70	-40/+50	38,5
TCBB/6-710/L	5604633400	930	710	849	4,2	62	14.480	-40/+70	-	46,0

\* Schalldruckpegel, gemessen in der Entfernung von ca. 3-fachem Laufraddurchmesser oder min. 1,5 Meter (im Freifeld).

Modell	Artikel Nr.	Drehzahl [min <sup>-1</sup> ]	Durchmesser [mm]	Leistungsaufnahme max. [W]	Motorstrom	Schalldruckpegel* [dB(A)]	Volumenstrom (freibl.) [m <sup>3</sup> /h]	Fördermitteltemperaturen [°C]		Gewicht [kg]
					[A] 400 V			Min.	Max.	
Drehstrom 3~ 400 V, 50 Hz, 2 polig										
TCBT/2-250/H	5705080000	2775	250	114	0,2	62	1.730	-40/+40	-40/+40	8,0
Drehstrom 3~ 400 V, 50 Hz, 4 polig										
TCBT/4-250/H	5705080400	1470	250	42	0,2	42	900	-40/+40	-40/+40	8,0
TCBT/4-315/H	5705080500	1445	315	99	0,3	51	1.950	-40/+40	-40/+40	11,0
TCBT/4-355/H	5705080600	1415	355	117	0,3	52	2.470	-40/+40	-40/+40	13,2
TCBT/4-400/H	5740124300	1410	400	268	0,5	60	4.950	-40/+40	-40/+40	15,5
TCBT/4-450/H	5604285700	1405	450	526	1,1	63	6.650	-40/+70	-40/+50	21,0
TCBT/4-500/H	5603999800	1420	500	641	1,5	66	7.590	-40/+70	-40/+50	25,0
TCBT/4-560/L	5604307900	1415	560	1184	2,2	68	12.090	-40/+70	-40/+50	33,0
TCBT/4-560/H	5603994600	1390	560	1348	2,4	69	13.370	-40/+70	-40/+50	34,7
TCBT/4-630/L	5604308900	1410	630	1768	3,4	70	16.370	-40/+70	-40/+40	39,0
TCBT/4-630/H	5604308700	1400	630	1940	3,6	70	17.030	-40/+70	-40/+50	40,0
TCBT/4-710/L	5603928300	1435	710	2175	3,7	73	20.290	-40/+40	-40/+40	46,0
TCBT/4-710/H	5603928400	1460	710	3441	6,1	73	26.420	-40/+40	-40/+40	54,0
TCBT/4-800/L	5605768700	1460	800	3750	6,5	76	29.950	-40/+40	-40/+40	65,0
TCBT/4-800/K	5605768600	1460	800	5177	8,8	76	34.950	-40/+40	-40/+40	68,0
TCBT/4-800/G	5605768500	1470	800	6146	11,1	77	38.500	-40/+40	-40/+40	81,0
TCBT/4-800/H	5605768400	1475	800	7688	13,0	78	42.490	-40/+40	-40/+40	89,0
Drehstrom 3~ 400 V, 50 Hz, 6 polig										
TCBT/6-355/H	5604586700	900	355	97	0,2	47	2.250	-40/+70	-40/+50	13,2
TCBT/6-400/H	5605049500	860	400	116	0,2	49	2.970	-40/+70	-40/+50	15,5
TCBT/6-450/H	5604311100	940	450	161	0,4	54	4.020	-40/+70	-40/+50	20,7
TCBT/6-500/H	5604317900	930	500	198	0,5	57	4.990	-40/+70	-40/+50	24,8
TCBT/6-560/H	5605776600	920	560	363	0,8	60	7.630	-40/+70	-40/+50	33,5
TCBT/6-630/L	5603999600	915	630	595	1,3	60	10.940	-40/+70	-40/+50	38,0
TCBT/6-630/H	5603999500	950	630	906	2,7	62	13.610	-40/+70	-40/+50	38,5
TCBT/6-710/L	5605766500	910	710	967	2,0	62	16.240	-40/+70	-40/+40	46,0
TCBT/6-710/H	5605766400	910	710	1378	3,1	63	19.120	-40/+70	-40/+40	46,0

\* Schalldruckpegel, gemessen in der Entfernung von ca. 3-fachem Laufraddurchmesser oder min. 1,5 Meter (im Freifeld).

## TYPENSCHLÜSSEL

<b>T</b>	<b>C</b>	<b>B</b>	<b>T</b>	<b>4</b>	<b>4</b>	<b>0</b>	<b>0</b>	<b>H</b>	<b>B</b>			
1	2	3	4	5	6			7	8	9		

- 1 - **T**: Rohrventilator.
- 2 - **C**: Serienbezeichnung.
- 3 - Material der Flügel:  
**B**: Aluminiumdruckguss
- 4 - Netzanschluss:  
**B**: 1~ 230 V / 50 Hz  
**T**: 3~ 400 V / 50 Hz
- 5 - Anzahl Pole im Motor (~ Drehzahl)
- 6 - Laufraddurchmesser (Nenn Durchmesser)
- 7 - Flügelstellung
- 8 - Luftrichtung  
**B**: Standard
- 9 - Besonderheiten  
**PTC**: Normmotor mit Kaltleiter  
**EX**: Mit ATEX Zulassung

## ABMESSUNGEN (MM)

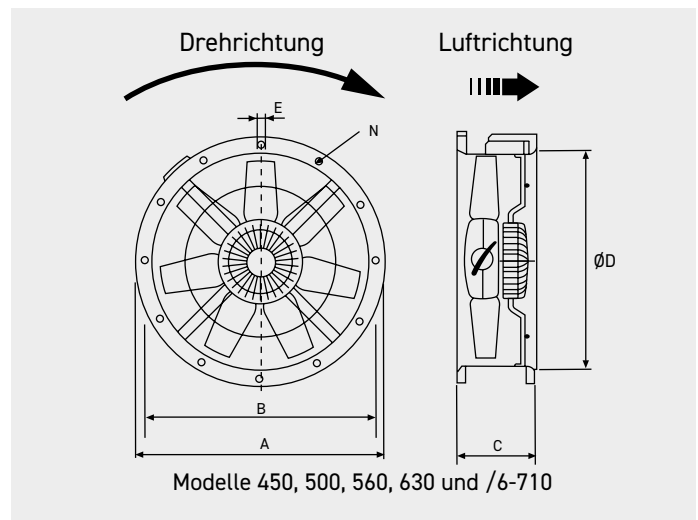
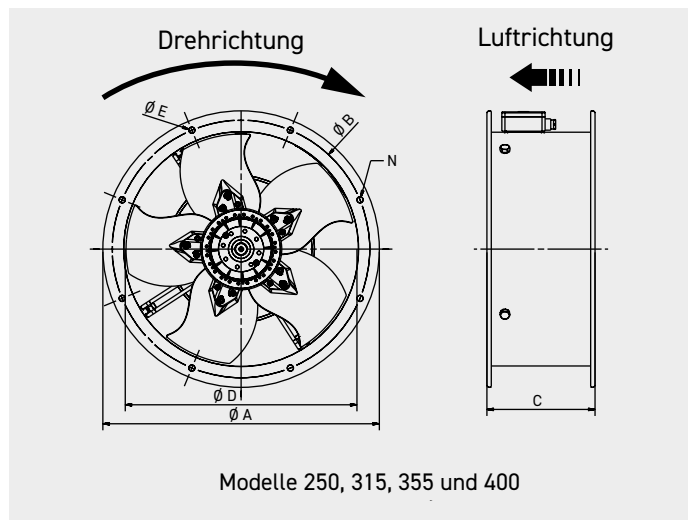

MODELL	Ø A	Ø B	C	Ø D	Ø E	N ANZAHL BOHRUNGEN
250	327	292	170	254	10	4
315	386	355	170	315	10	8
355	426	395	170	355	10	8
400 (6 polig)	487	450	170	400	12	8
400 (4 polig)	487	450	210	400	12	8
450	537	500	180	450	12	8
500	595	560	180	500	12	12
560	655	620	240	560	12	12
630	725	690	240	630	12	12
710 (6 polig)	806	770	240	710	12	16

ABMESSUNGEN (MM)

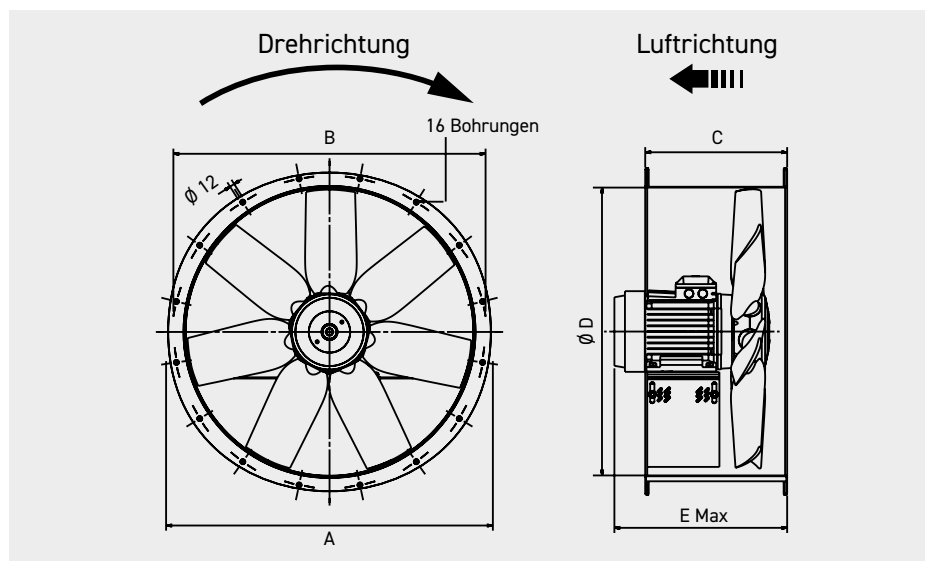

MODEL	Ø A	B	C	Ø D	E		
					4 POLIG	6 POLIG	8 POLIG
710/L (4 polig)	806	770	380	710	415	-	-
710/H (4 polig)	806	770	380	710	444	-	-
800/L	896	860	380	800	437	408	383
800/K	896	860	380	800	448	437	408
800/G	896	860	380	800	447 (5,5kW) 552 (7,5kW)	448	437
800/H	896	860	380	800	552	477	437

SCHALLDATEN

Die in der Tabelle „Technische Daten“ und den Kennlinien angegebenen Schallwerte entsprechen dem Schalldruckpegel dB(A), gemessen unter Freifeldbedingungen in einem Abstand vom ca. 3-fachem Laufraddurchmesser oder min. 1,5 Meter (im Freifeld). Schallleistungspegelspektrum in dB(A) bei den entsprechenden Oktavband-Durchschnittsfrequenzen in Hz.

MODELL	63	125	250	500	1000	2000	4000	8000	LWA
/2-250/H	31	44	59	65	74	70	64	56	76
/4-250/H	24	37	41	47	52	52	47	41	57
/4-315/H	40	51	45	53	59	59	51	43	63
/4-355/H	24	40	45	55	58	58	49	42	62
/4-400/H	46	53	59	66	69	69	66	58	74
/4-450/H	46	58	65	71	73	71	67	59	77
/4-500/H	50	62	69	75	76	75	70	62	81
/4-560/L	52	64	71	77	78	77	72	64	83
/4-560/H	53	65	72	78	79	78	73	65	84
/4-630/L	56	67	75	80	82	81	76	68	87
/4-630/H	56	67	75	80	82	81	76	68	87
/4-710/L	53	69	79	85	86	84	78	70	91
/4-710/H	60	72	79	85	86	85	80	72	91
/4-800/L	57	73	83	90	91	88	82	74	95
/4-800/K	63	75	82	88	90	88	84	76	94
/4-800/G	64	76	83	89	90	89	84	76	95
/4-800/H	66	77	84	90	92	91	86	78	96

MODELL	63	125	250	500	1000	2000	4000	8000	LWA
/6-355/H	31	42	49	55	57	55	51	43	61
/6-400/H	33	44	51	57	59	58	53	45	64
/6-450/H	40	51	58	63	64	62	56	48	69
/6-500/H	43	53	61	66	66	64	58	50	71
/6-560/L	46	57	64	69	70	67	61	53	74
/6-560/H	46	56	64	69	69	67	61	53	74
/6-630/L	49	59	66	71	72	70	64	56	77
/6-630/H	51	61	68	73	74	72	66	58	79
/6-710/L	52	62	69	75	75	73	67	59	80
/6-710/H	53	64	71	76	77	75	69	61	82

## LEISTUNGSKURVEN

- $q_v$ : Volumenstrom in  $m^3/h$  und  $m^3/s$ .
- $p_{sf}$ : Statischer Druck in Pa.
- $p_g$ : Druckverlust des Berührungsschutzgitters in Pa.
- SFP: Spezifische Ventilatorleistung (Specific fan power) in  $W/m^3/s$ .
- P: Eingangsleistung in W.
- Messkategorie: A.
- Effizienzklasse: Statisch.
- Ventilator Effizienz ohne Drehzahlregelung.
- Ventilator mit Berührungsschutzgitter getestet.
- Leistungsdaten gemäß ISO 5801.
- Schalldruckpegel, gemessen in der Entfernung von ca. 3-fachem Laufraddurchmesser oder min. 1,5 Meter (im Freifeld)

MC	Messkategorie
EC	Effizienzklasse (stat. = statisch // total)
VSD	Geschwindigkeitsregelung: mit dem Lüfter geliefert
SR	Spezifisches Verhältnis
$\eta$	Effizienz in %
N	Effizienzklasse
[kW]	Aufgenommene Leistung
[ $m^3/h$ ]	Volumenstrom
[Pa]	Statischer Druck
[ $min^{-1}$ ]	Drehzahl

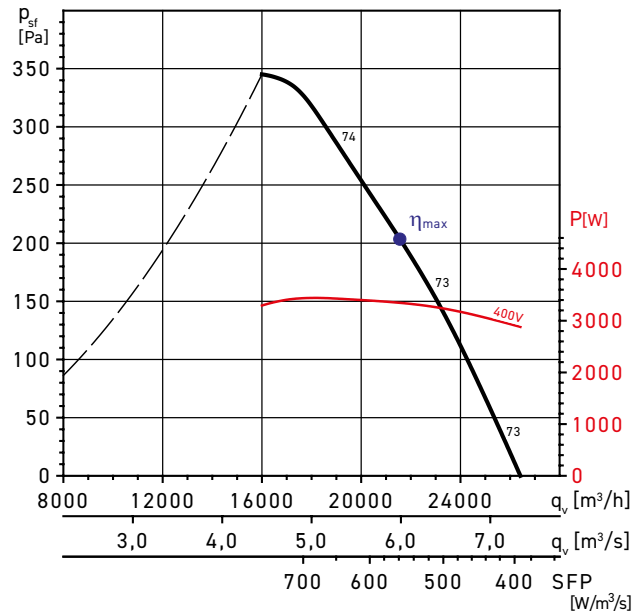

MC	EC	VSD	SR	$\eta$	N	[kW]	[ $m^3/h$ ]	[Pa]	[ $min^{-1}$ ]
D	total	nein	1	61,4	64,4	3,346	21563	341	1451

## LEISTUNGSKURVEN, 2- POLIGE MODELLE

TCBB/2-250/H

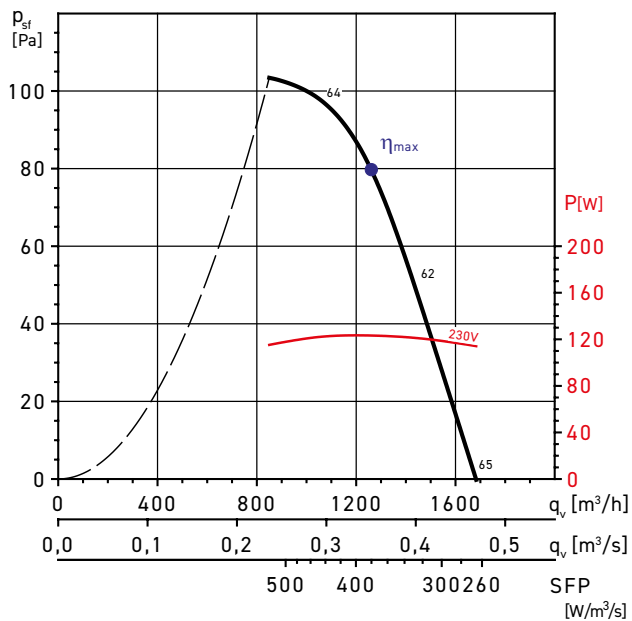

TCBT/2-250/H

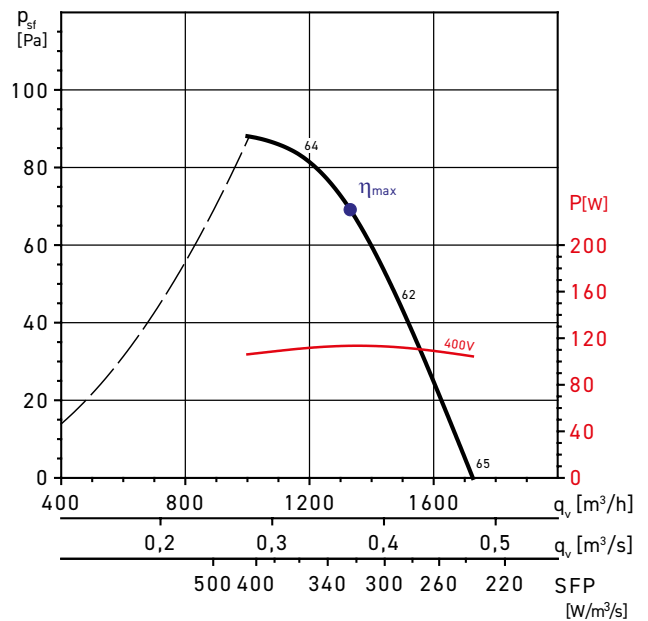

LEISTUNGSKURVEN, 4- POLIGE MODELLE

TCBB/4-250/H

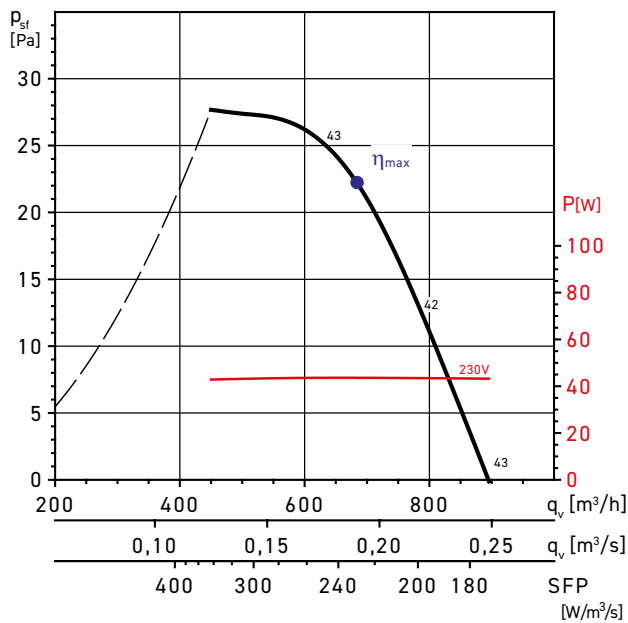

TCBB/4-315/H

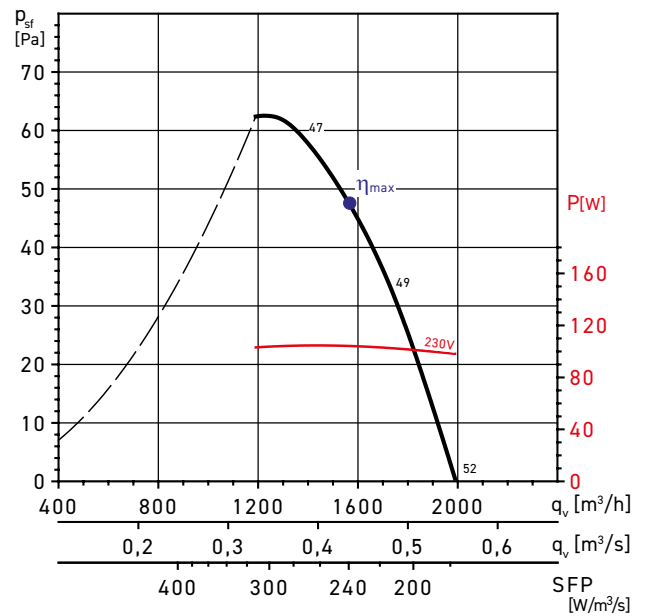

TCBB/4-355/H

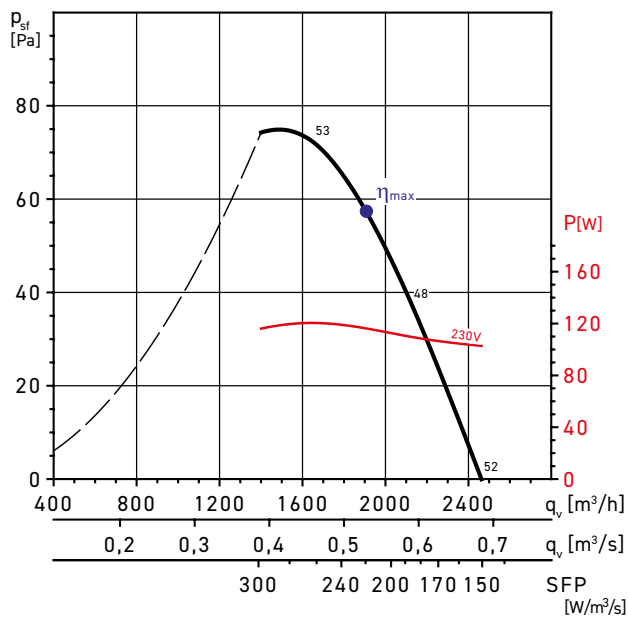

TCBB/4-400/H

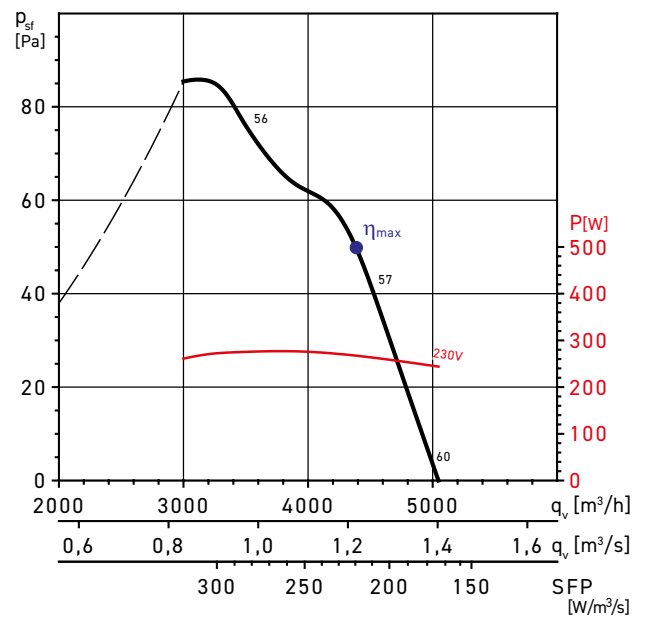

MC	EC	VSD	SR	$\eta$	N	[kW]	[ $m^3/h$ ]	[Pa]	[ $min^{-1}$ ]
D	total	nein	1	48,5	58,4	0,267	4386	106	1397

LEISTUNGSKURVEN, 4- POLIGE MODELLE

TCBB/4-450/H

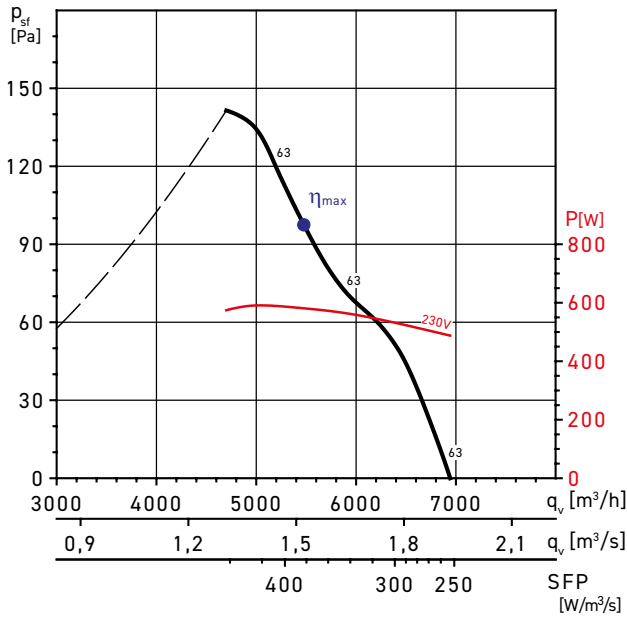

MC	EC	VSD	SR	η	N	[kW]	[m³/h]	[Pa]	[min <sup>-1</sup> ]
C	stat.	nein	1	32,3	40,1	0,582	4783	142	1368

TCBB/4-500/H

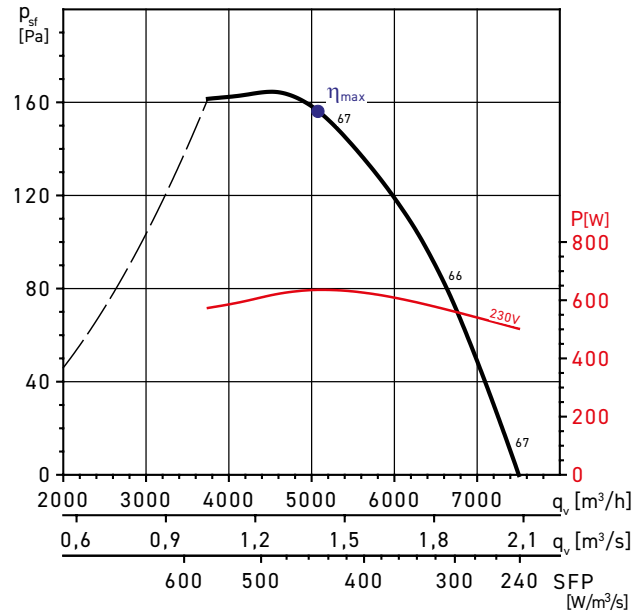

MC	EC	VSD	SR	η	N	[kW]	[m³/h]	[Pa]	[min <sup>-1</sup> ]
C	stat.	nein	1	34,5	42,1	0,636	5075	156	1367

TCBB/4-560/L

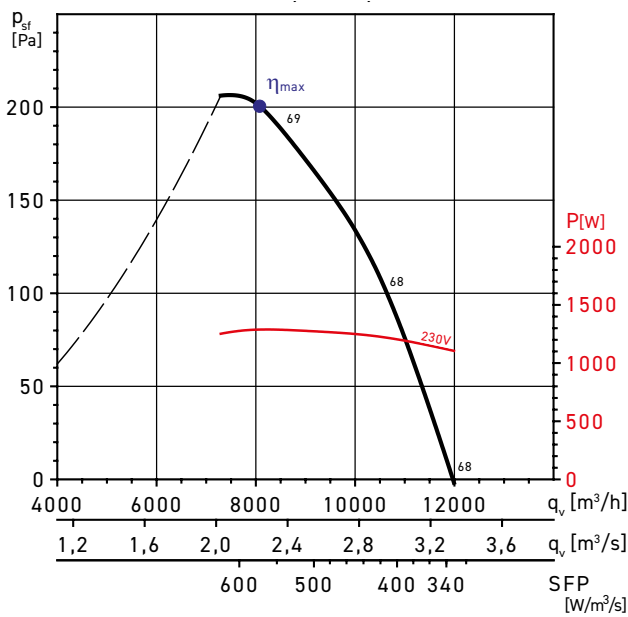

MC	EC	VSD	SR	η	N	[kW]	[m³/h]	[Pa]	[min <sup>-1</sup> ]
C	stat.	nein	1	34,7	40,3	1,288	8071	200	1382

TCBB/4-560/H

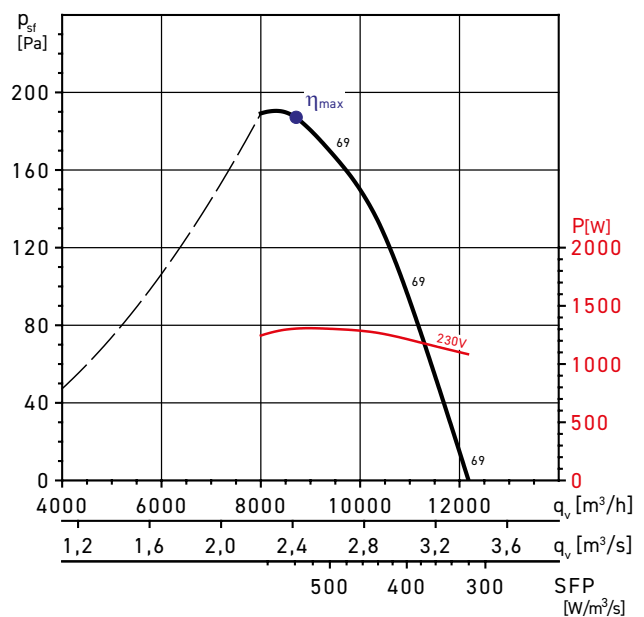

MC	EC	VSD	SR	η	N	[kW]	[m³/h]	[Pa]	[min <sup>-1</sup> ]
C	stat.	nein	1	34,6	40,2	1,305	8700	187	1370

LEISTUNGSKURVEN, 4- POLIGE MODELLE

TCBB/4-630/L

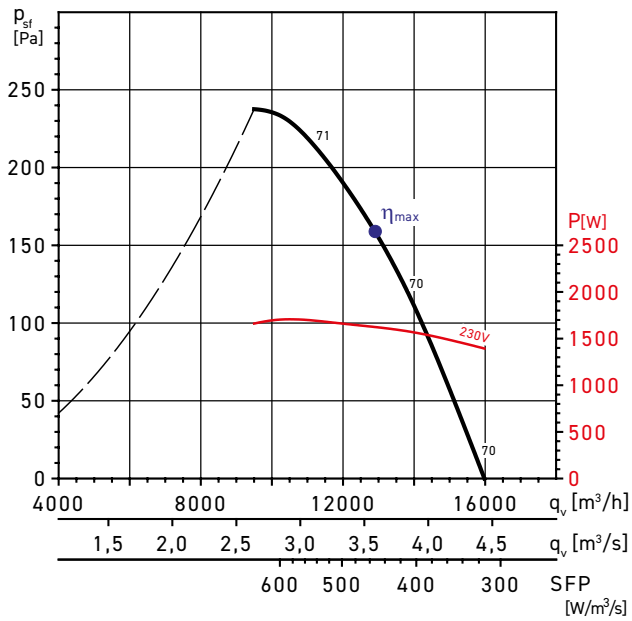

MC	EC	VSD	SR	$\eta$	N	[kW]	[m³/h]	[Pa]	[min⁻¹]
D	total	nein	1	53,4	58,4	1,624	12.896	241	1332

TCBT/4-250/H

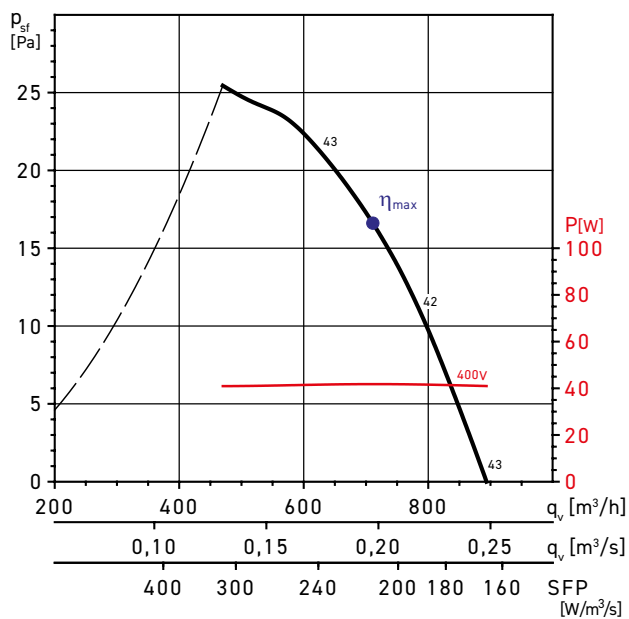

TCBT/4-315/H

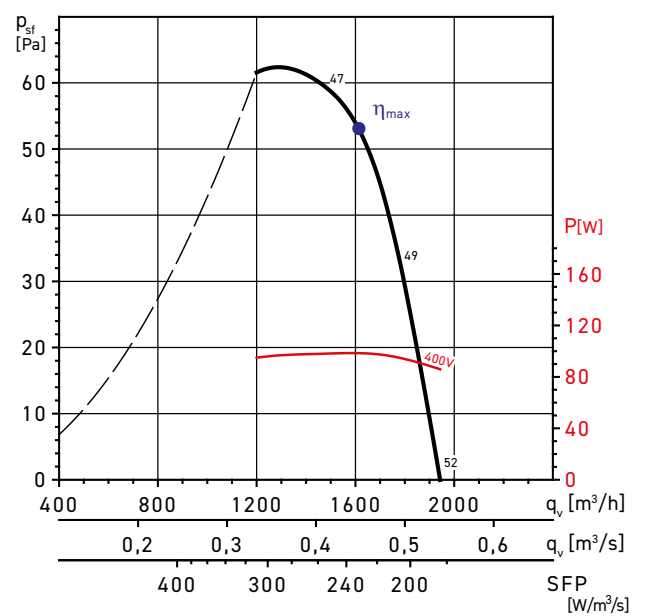



LEISTUNGSKURVEN, 4- POLIGE MODELLE

TCBT/4-355/H

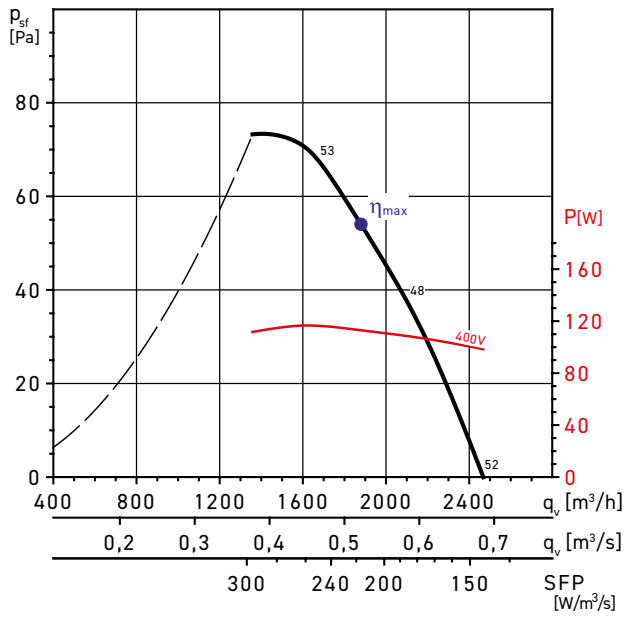

TCBT/4-400/H

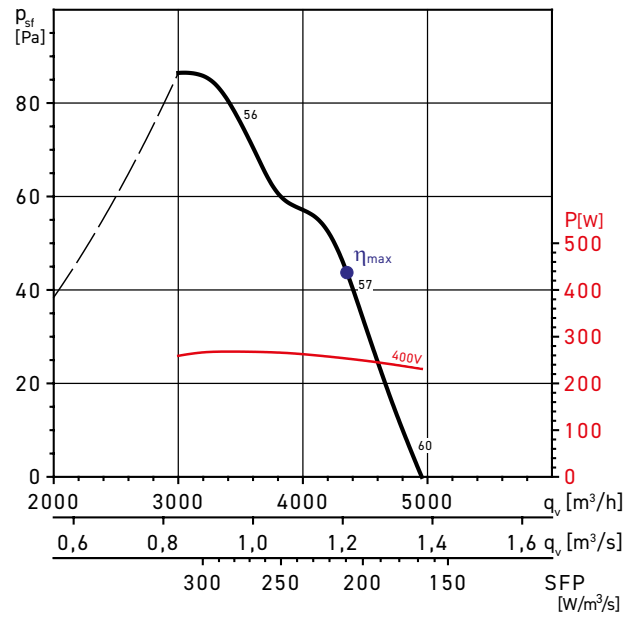

MC	EC	VSD	SR	η	N	[kW]	[m³/h]	[Pa]	[min⁻¹]
D	total	nein	1	47,9	58	0,255	4,281	103	1391

TCBT/4-450/H

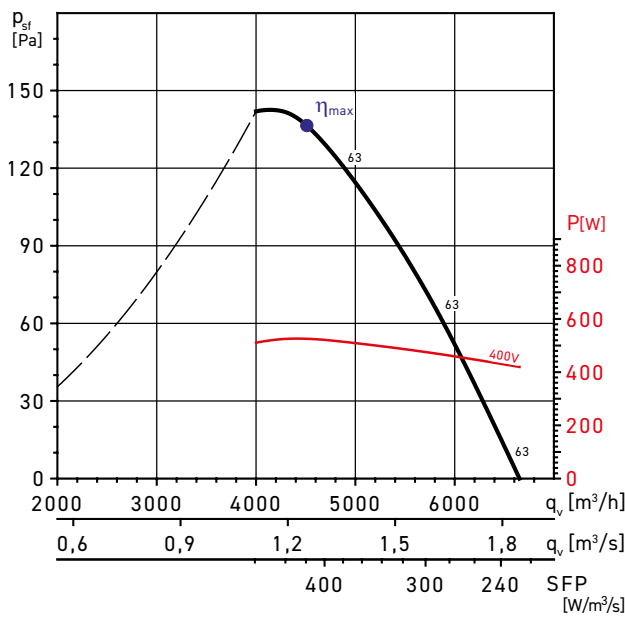

TCBT/4-500/H

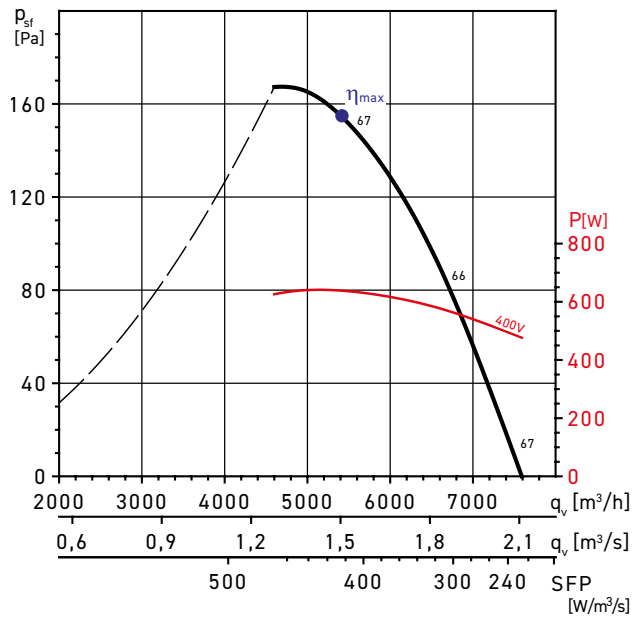

MC	EC	VSD	SR	η	N	[kW]	[m³/h]	[Pa]	[min⁻¹]
C	stat.	nein	1	32,4	40,5	0,526	4,510	136	1374

MC	EC	VSD	SR	η	N	[kW]	[m³/h]	[Pa]	[min⁻¹]
C	stat.	nein	1	36,3	43,9	0,638	5,409	155	1381

LEISTUNGSKURVEN, 4- POLIGE MODELLE

TCBT/4-560/L

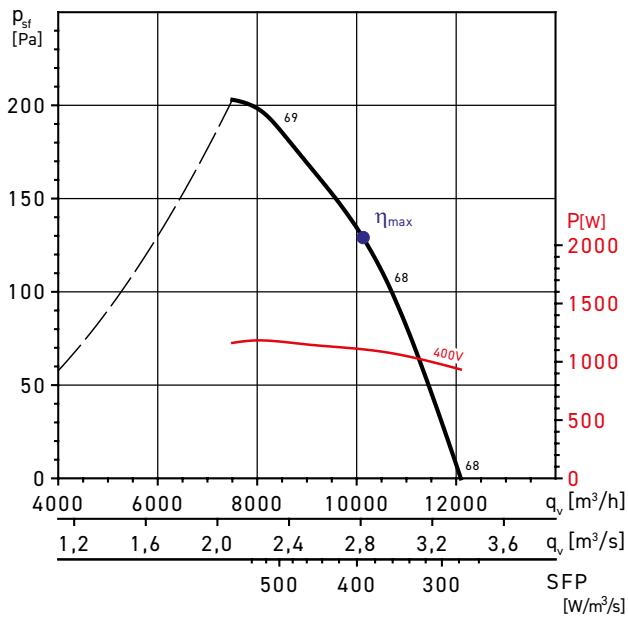

TCBT/4-560/H

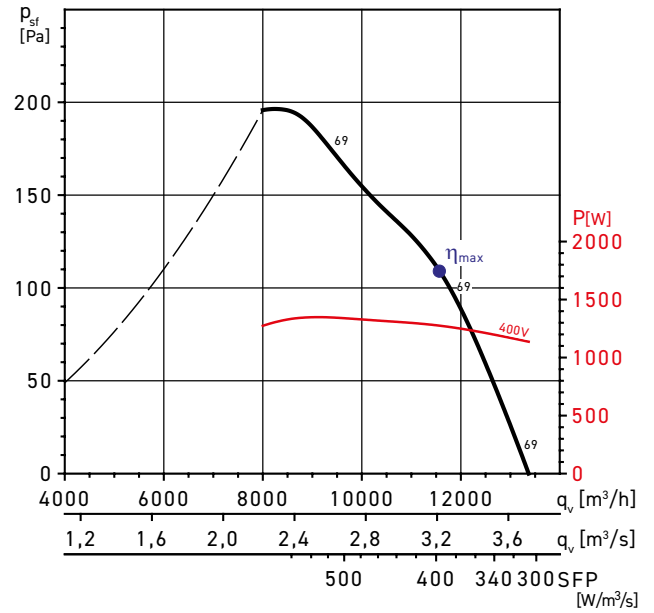

MC	EC	VSD	SR	$\eta$	N	[kW]	[m³/h]	[Pa]	[min⁻¹]
D	total	nein	1	53,2	59,3	1,107	10127	208	1390

MC	EC	VSD	SR	$\eta$	N	[kW]	[m³/h]	[Pa]	[min⁻¹]
D	total	nein	1	53,4	59,1	1,275	11576	212	1372

TCBT/4-630/L

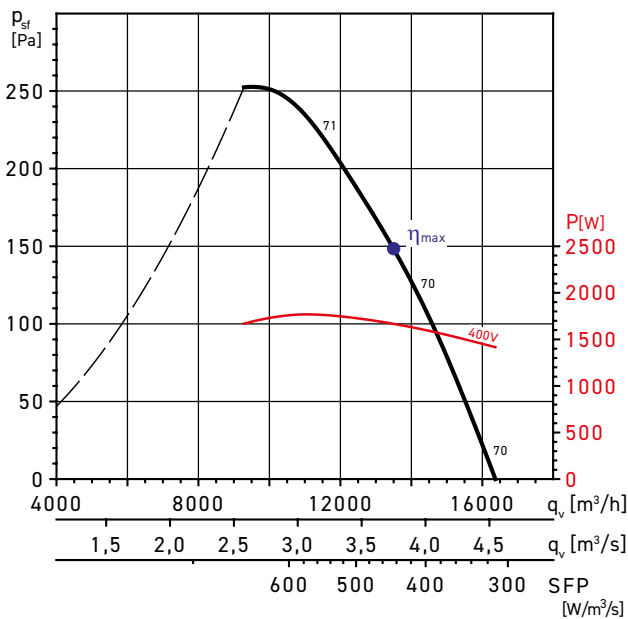

TCBT/4-630/H

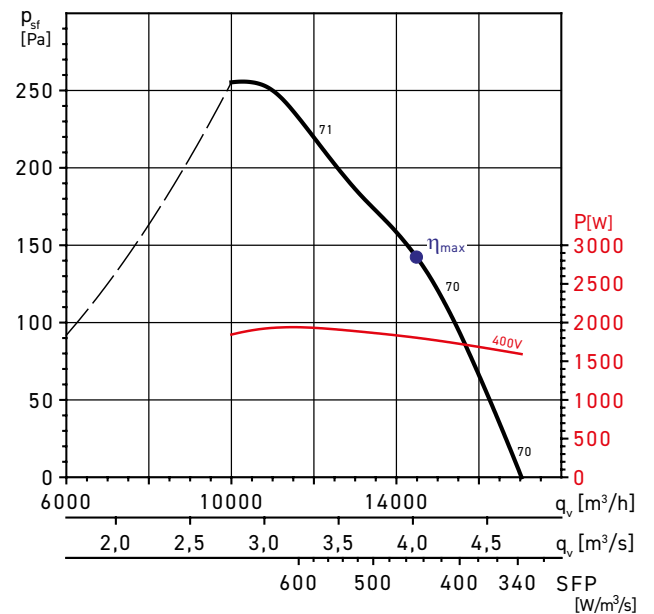

MC	EC	VSD	SR	$\eta$	N	[kW]	[m³/h]	[Pa]	[min⁻¹]
D	total	nein	1	53,4	58,3	1,667	13505	236	1390

MC	EC	VSD	SR	$\eta$	N	[kW]	[m³/h]	[Pa]	[min⁻¹]
D	total	nein	1	54,4	59,1	1,804	14481	244	1383

LEISTUNGSKURVEN, 4- POLIGE MODELLE

TCBT/4-710/L

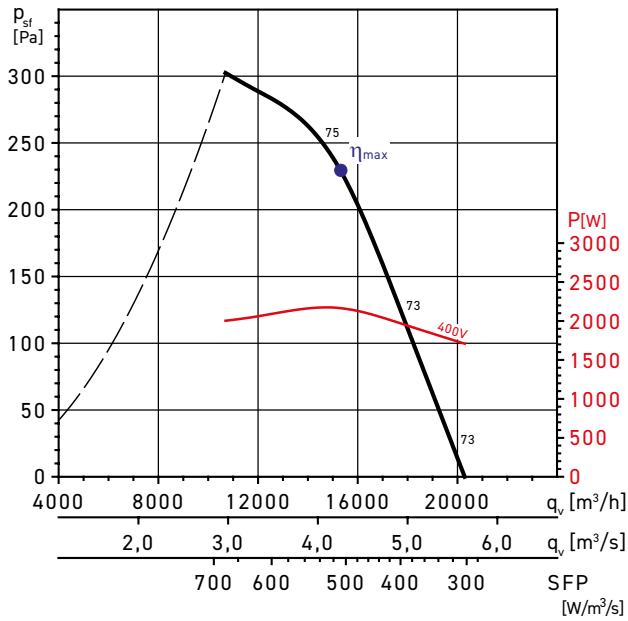

MC	EC	VSD	SR	$\eta$	N	[kW]	[m³/h]	[Pa]	[min⁻¹]
D	total	nein	1	58,7	62,9	2,166	15306	299	1414

TCBT/4-710/H

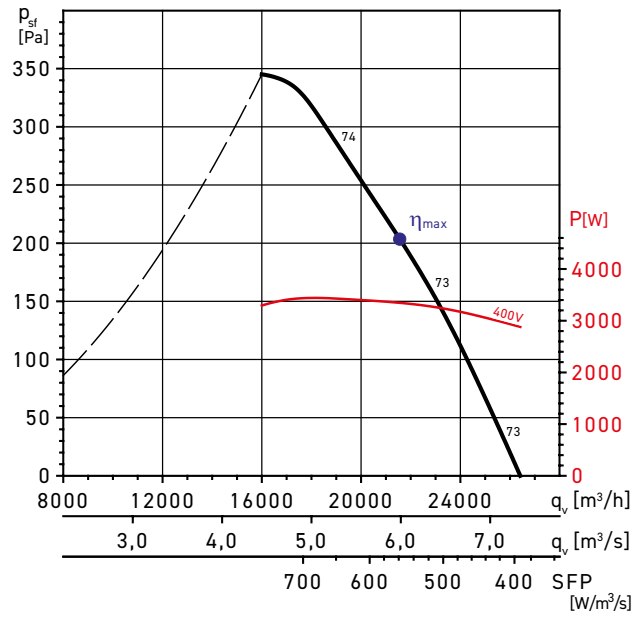

MC	EC	VSD	SR	$\eta$	N	[kW]	[m³/h]	[Pa]	[min⁻¹]
D	total	nein	1	61,4	64,4	3,346	21563	341	1451

TCBT/4-800/L

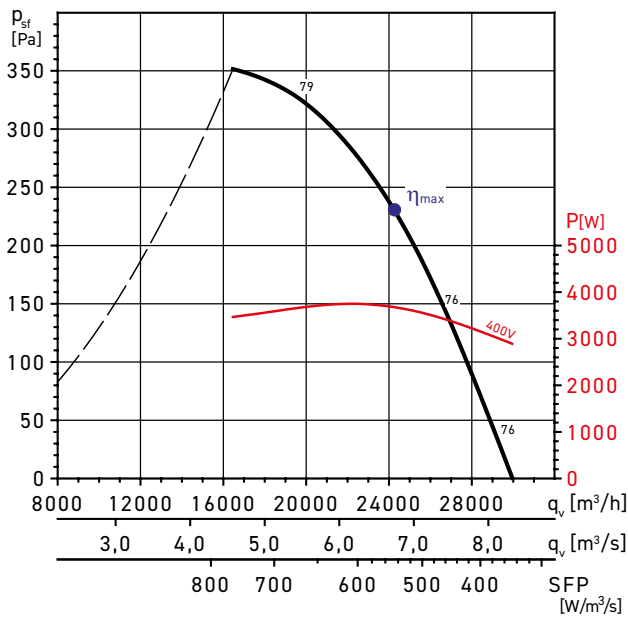

MC	EC	VSD	SR	$\eta$	N	[kW]	[m³/h]	[Pa]	[min⁻¹]
D	total	nein	1	62,4	65,2	3,678	24248	339	1445

TCBT/4-800/K

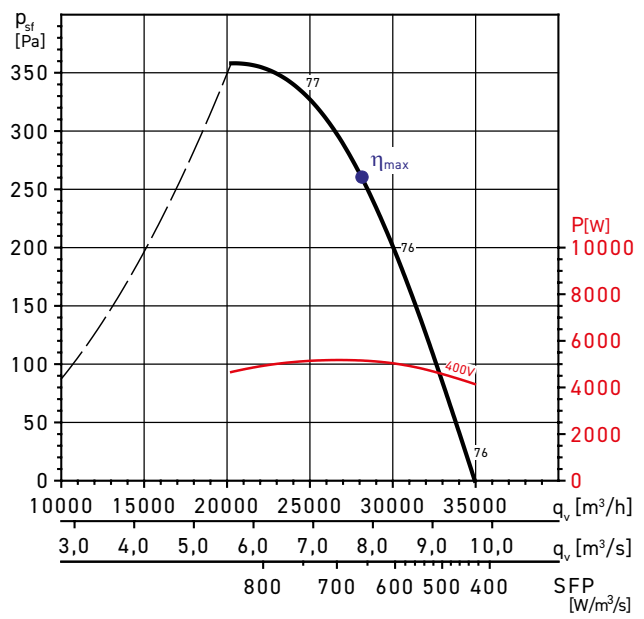

MC	EC	VSD	SR	$\eta$	N	[kW]	[m³/h]	[Pa]	[min⁻¹]
D	total	nein	1	61,6	63,4	5,156	28120	406	1445

LEISTUNGSKURVEN, 4- POLIGE MODELLE

TCBT/4-800/G

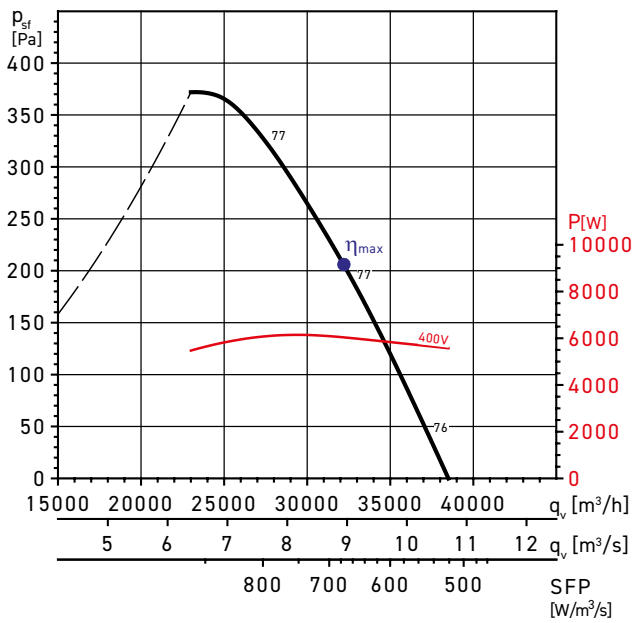

TCBT/4-800/H

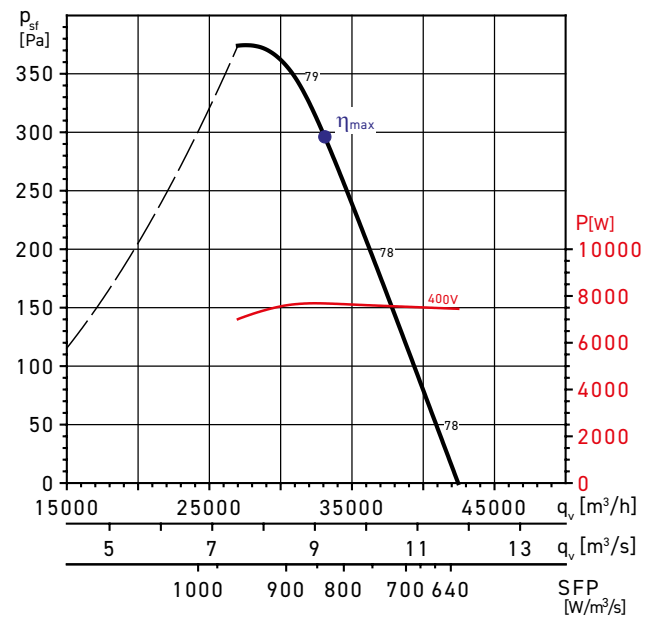

MC	EC	VSD	SR	$\eta$	N	[kW]	[m³/h]	[Pa]	[min⁻¹]
D	total	nein	1	58,9	60,3	6,038	32195	397	1460

MC	EC	VSD	SR	$\eta$	N	[kW]	[m³/h]	[Pa]	[min⁻¹]
D	total	nein	1	59,6	60,3	7,682	33100	498	1468

LEISTUNGSKURVEN, 6- POLIGE MODELLE

TCBB/6-355/H

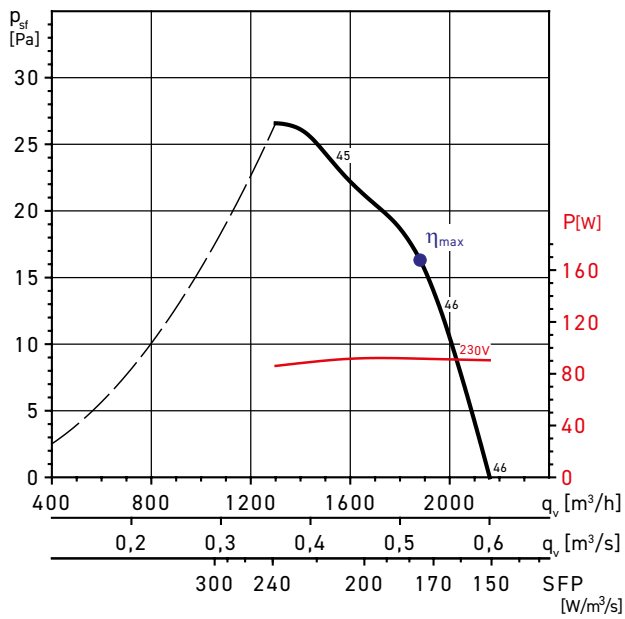

TCBB/6-400/H

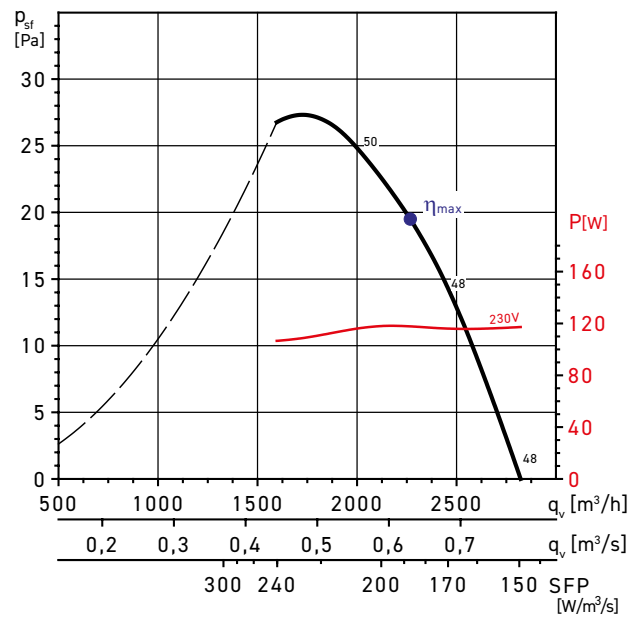

TCBB/6-560/H

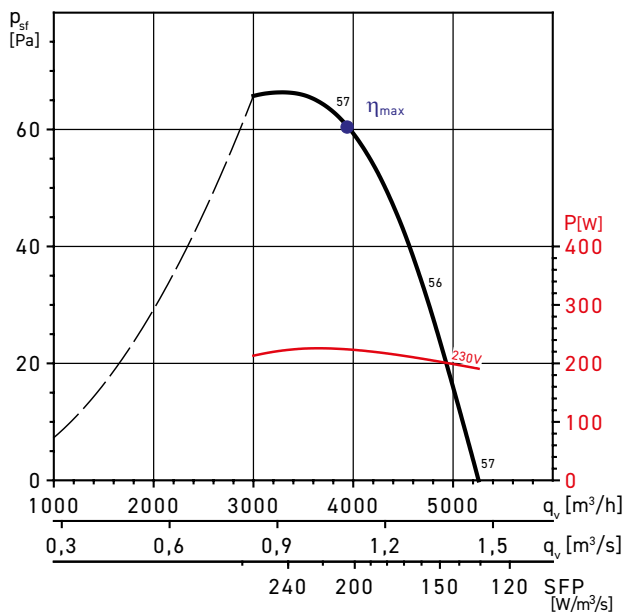

TCBB/6-560/L

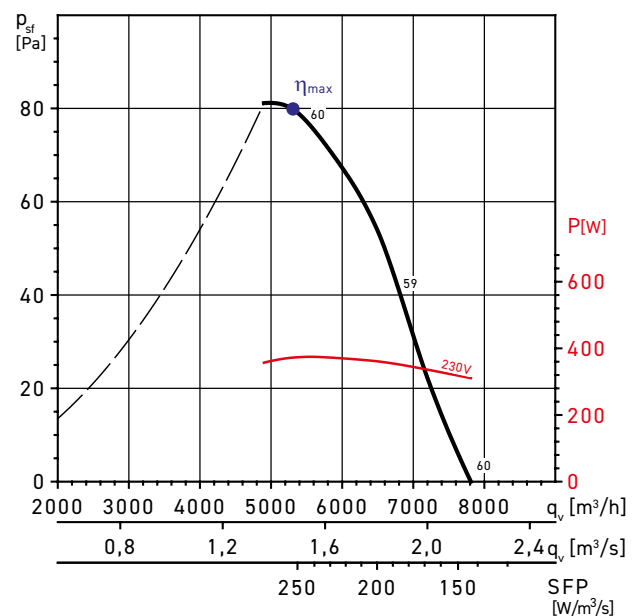

MC	EC	VSD	SR	$\eta$	N	[kW]	[m³/h]	[Pa]	[min⁻¹]
C	stat.	nein	1	29,6	40,0	0,224	3945	61	886

MC	EC	VSD	SR	$\eta$	N	[kW]	[m³/h]	[Pa]	[min⁻¹]
C	stat.	nein	1	31,6	40,6	0,372	5306	80	894

LEISTUNGSKURVEN, 6- POLIGE MODELLE

TCBB/6-630/L

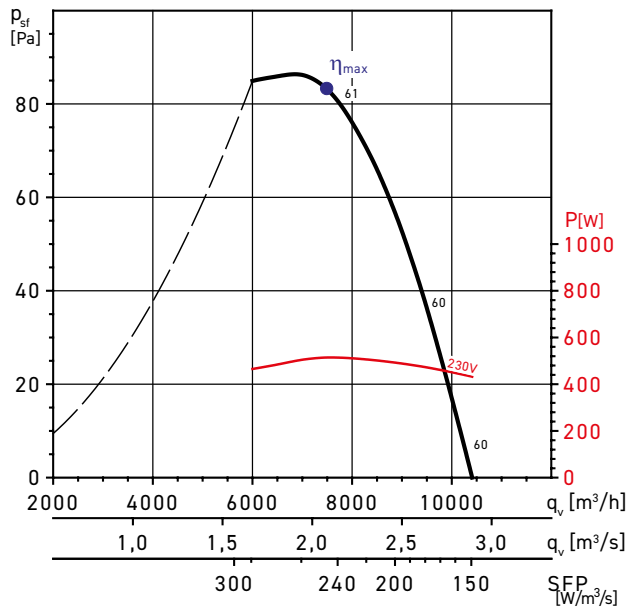

TCBB/6-710/L

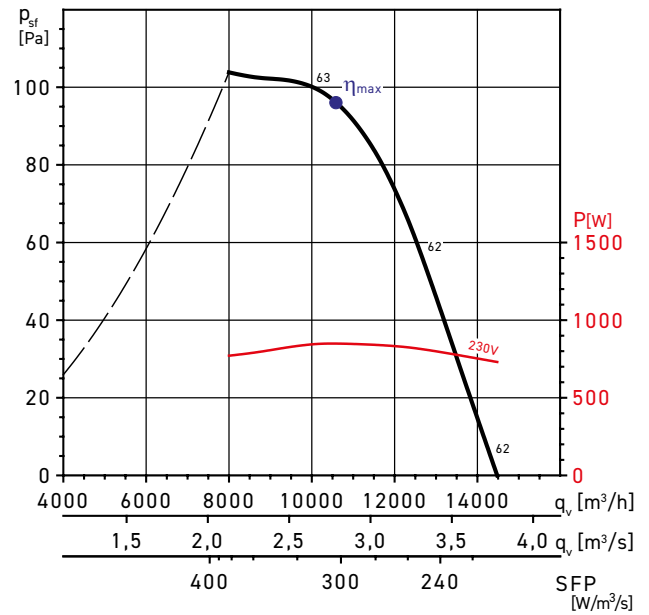

MC	EC	VSD	SR	$\eta$	N	[kW]	[m <sup>3</sup> /h]	[Pa]	[min <sup>-1</sup> ]
C	stat.	nein	1	33,7	41,9	0,514	7499	83	889

MC	EC	VSD	SR	$\eta$	N	[kW]	[m <sup>3</sup> /h]	[Pa]	[min <sup>-1</sup> ]
C	stat.	nein	1	33,3	40,1	0,849	10587	96	901

TCBT/6-355/H

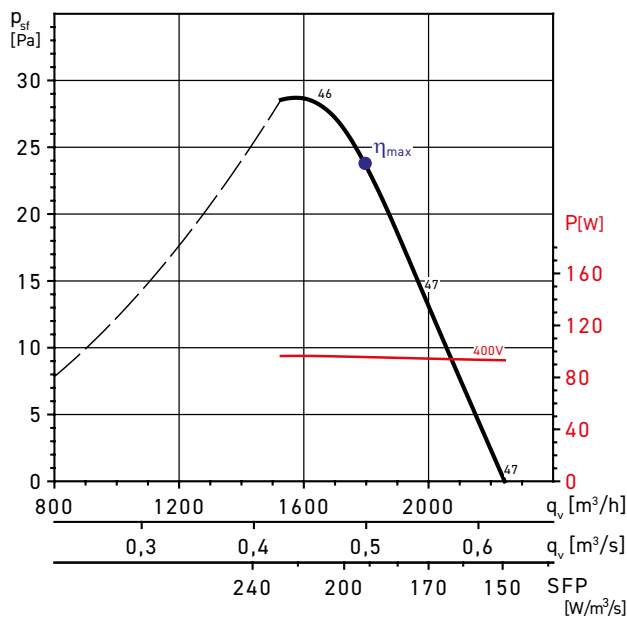

TCBT/6-400/H

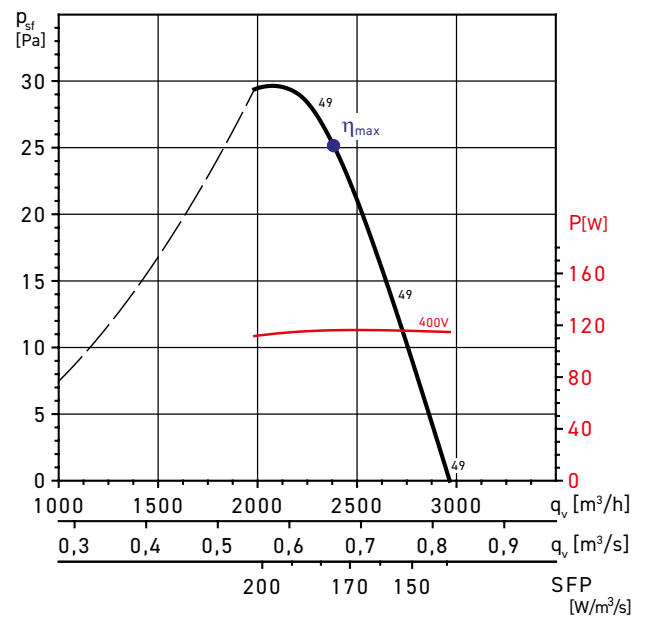

LEISTUNGSKURVEN, 6- POLIGE MODELLE

TCBT/6-450/H

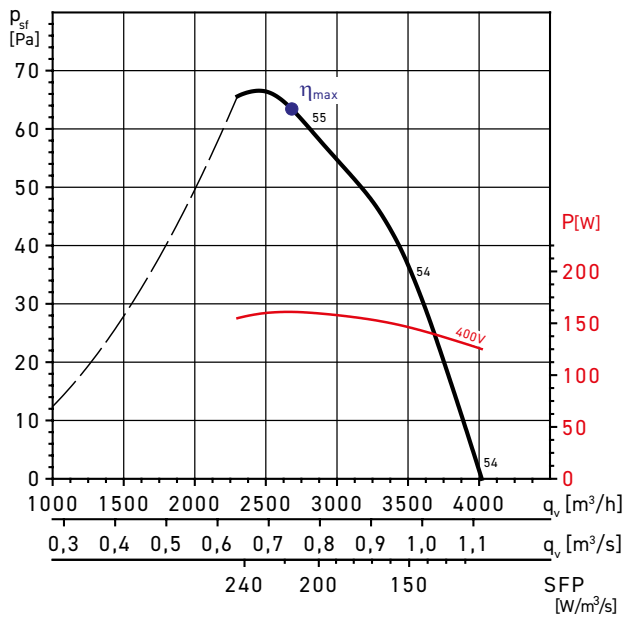

MC	EC	VSD	SR	$\eta$	N	[kW]	[m³/h]	[Pa]	[min⁻¹]
C	stat.	nein	1	29,1	40,4	0,161	2684	63	911

TCBT/6-500/H

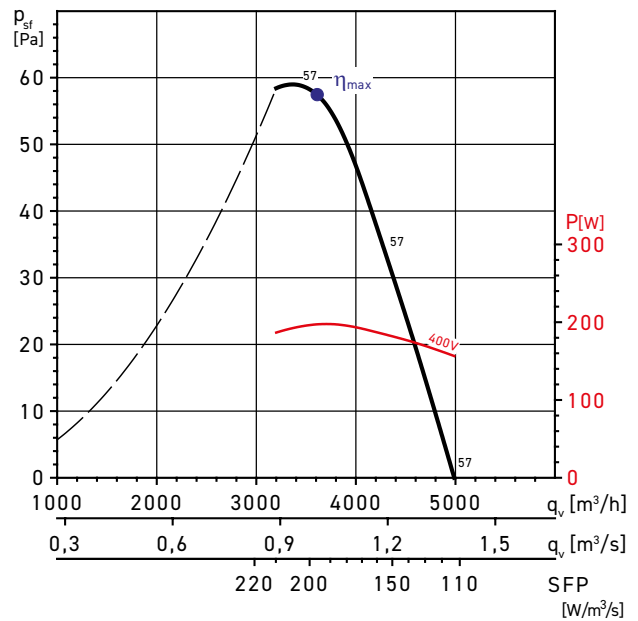

MC	EC	VSD	SR	$\eta$	N	[kW]	[m³/h]	[Pa]	[min⁻¹]
C	stat.	nein	1	29,2	40,0	0,197	3608	58	899

TCBT/6-560/H

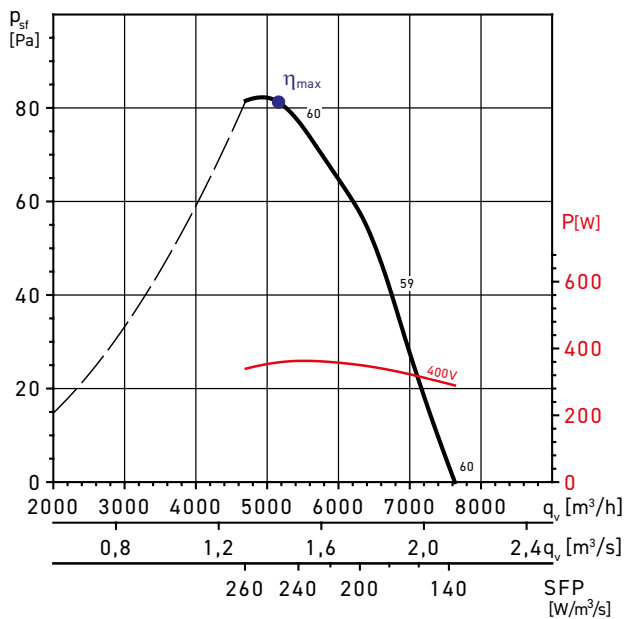

MC	EC	VSD	SR	$\eta$	N	[kW]	[m³/h]	[Pa]	[min⁻¹]
C	stat.	nein	1	32,5	41,6	0,359	5164	81	895

TCBT/6-630/L

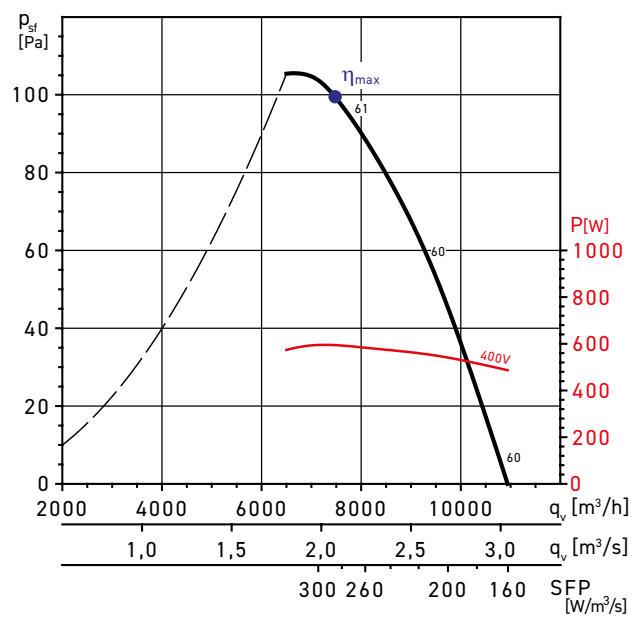

MC	EC	VSD	SR	$\eta$	N	[kW]	[m³/h]	[Pa]	[min⁻¹]
C	stat.	nein	1	34,6	42,4	0,594	7481	99	888

LEISTUNGSKURVEN, 6- POLIGE MODELLE

TCBT/6-630/H

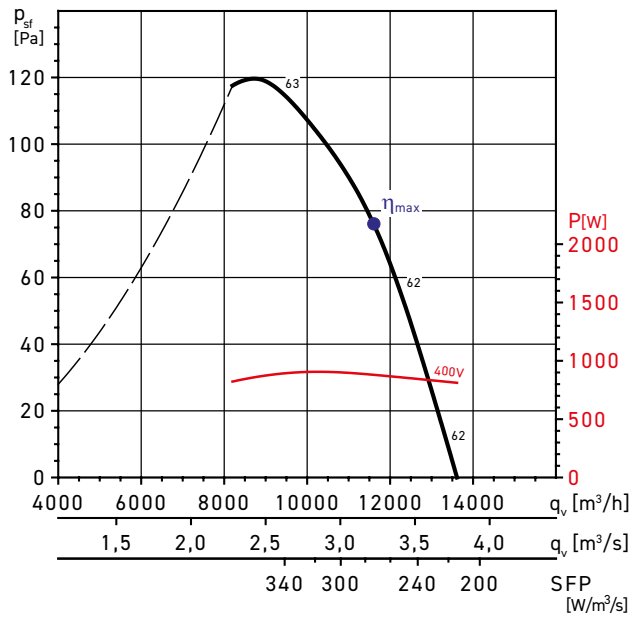

TCBT/6-710/L

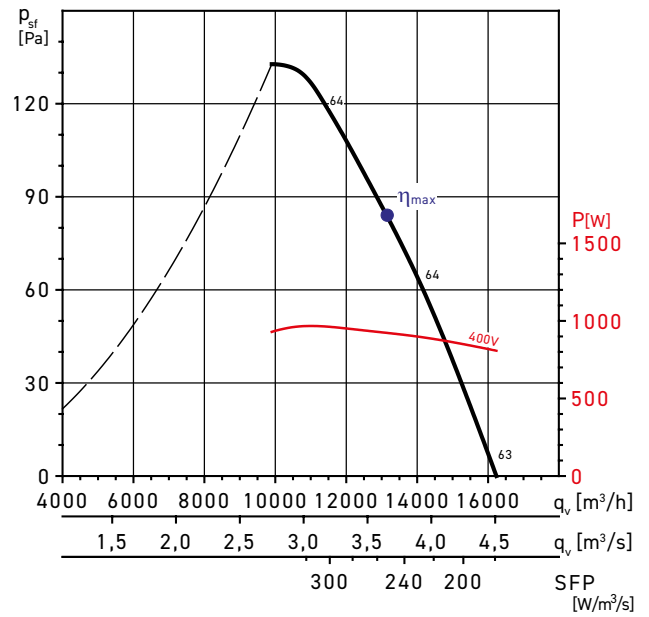

MC	EC	VSD	SR	η	N	[kW]	[m³/h]	[Pa]	[min⁻¹]
D	total	nein	1	51,7	58,4	0,88	11606	141	949

MC	EC	VSD	SR	η	N	[kW]	[m³/h]	[Pa]	[min⁻¹]
D	total	nein	1	53,7	60,3	0,921	13209	134	894

TCBT/6-710/H

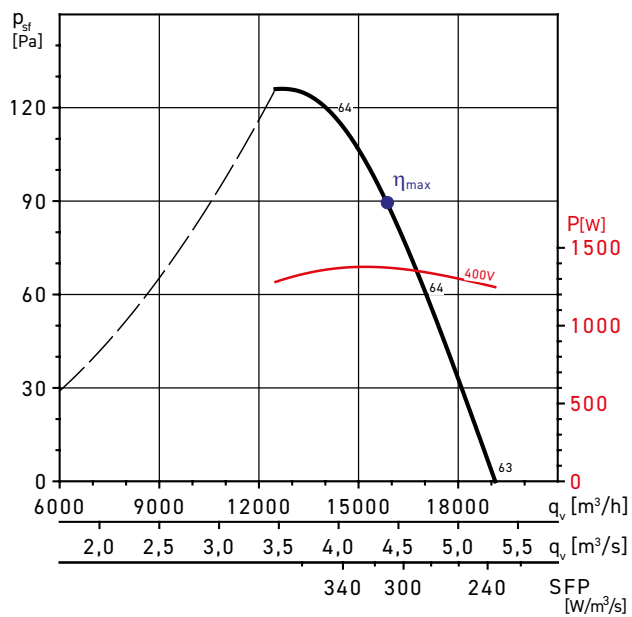

TCBT/6-800/L

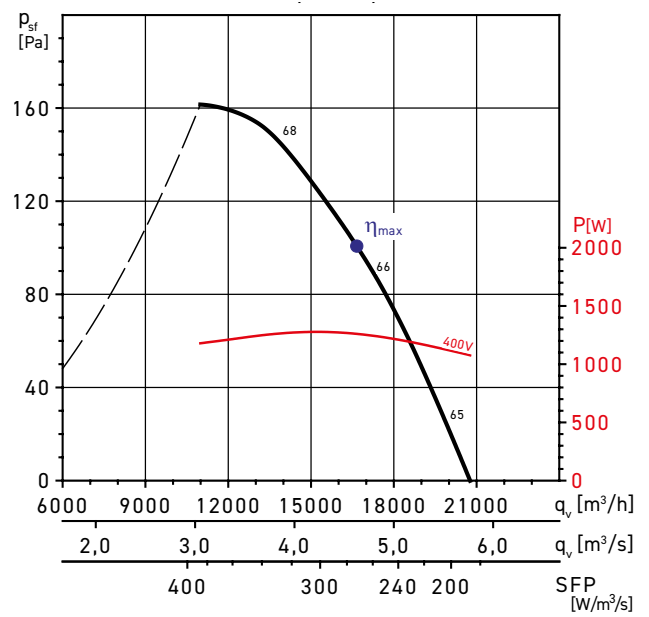

MC	EC	VSD	SR	η	N	[kW]	[m³/h]	[Pa]	[min⁻¹]
D	total	nein	1	52,7	58,2	1,376	15643	167	897

MC	EC	VSD	SR	η	N	[kW]	[m³/h]	[Pa]	[min⁻¹]
D	total	nein	1	56,0	61,7	1,26	16668	152	955



LEISTUNGSKURVEN, 6- POLIGE MODELLE

TCBT/6-800/K

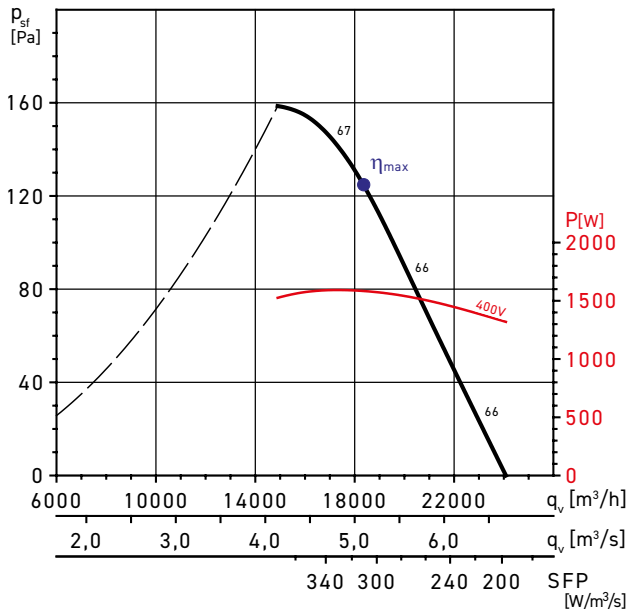

MC	EC	VSD	SR	$\eta$	N	[kW]	[m³/h]	[Pa]	[min⁻¹]
D	total	nein	1	60,1	65,2	1,584	18352	187	965

TCBT/6-800/G

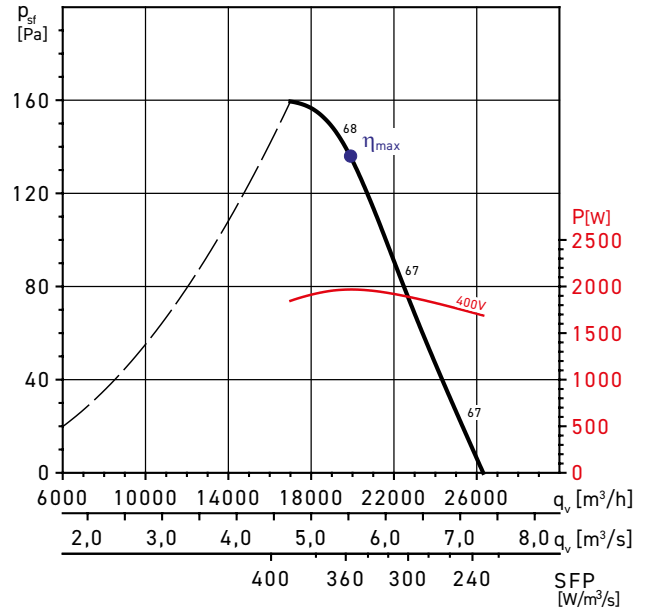

MC	EC	VSD	SR	$\eta$	N	[kW]	[m³/h]	[Pa]	[min⁻¹]
D	total	nein	1	58,6	63,1	1,968	19904	209	971

TCBT/6-800/H

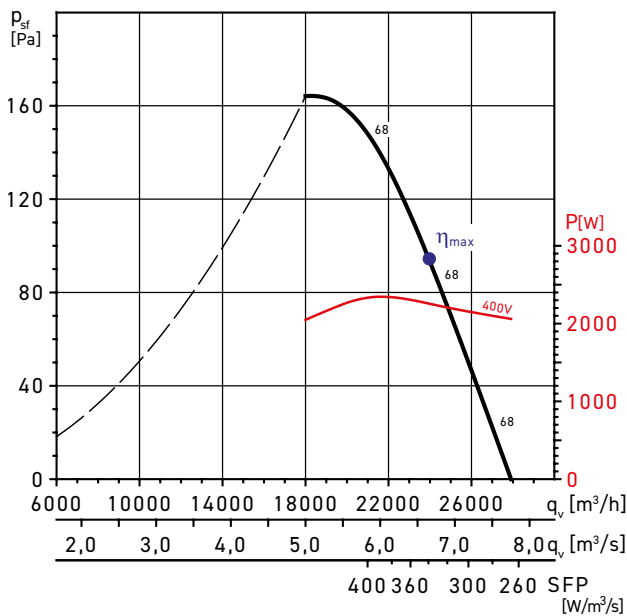

MC	EC	VSD	SR	$\eta$	N	[kW]	[m³/h]	[Pa]	[min⁻¹]
D	total	nein	1	59	63,1	2,257	23956	200	962

ANSCHLUSSSCHALTBILDER

TCBB Modelle 1~ 230 V, 50 Hz Ø 250, 315, 4-355

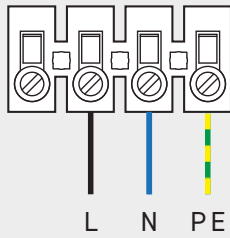

TCBB Modelle 1~ 230 V, 50 Hz Ø 4-400

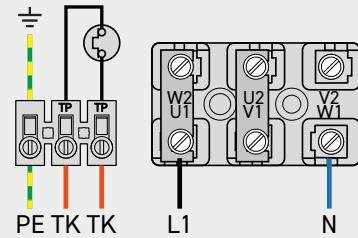

TCBB Modelle 1~ 230 V, 50 Hz Ø 6-355 / 6-400

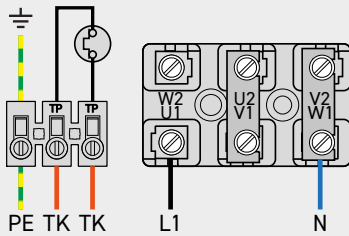

TCBT Modelle 3~ 400 V, 50 Hz, 4-315 und/4-355

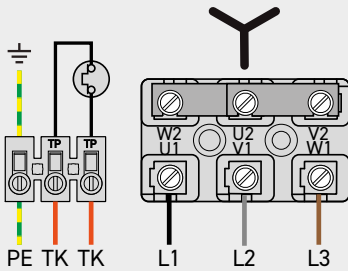

TCBT Modelle 3~ 400 V, 50 Hz,  
 alle außer: TCBT/2-250/H

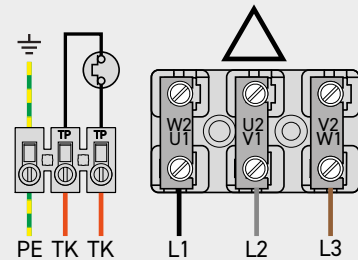

HCFT Modelle 3~ 400 V, 50 Hz,  
 alle außer: TCBT /4-710/x, /4-800/x und /6-800/x

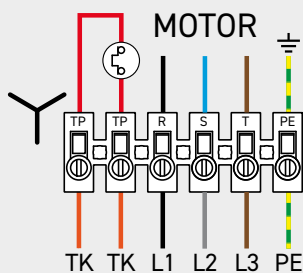

## ZUBEHÖR

### ZUBEHÖR DREHZAHLREGLUNG TCBB (1~ 230 V)



**MSD-2**  
Motorschutzschalter  
Schalt- und  
Schutzgerät für  
Motoren mit separat  
zum Klemmenbrett  
geführten  
Thermokontakt



**REB N(E)**  
Drehzahlsteller,  
Phasenanschnitt  
für Wechselstrom-  
modell.



**REV B**  
5-Stufentransformator  
ohne  
Motorschutzeinrichtung  
für Einphasenmotoren



**REV N**  
5-Stufentransformator,  
mit Schutzfunktion für  
Wechselstrommotoren  
mit separat zum  
Klemmenbrett  
geführten  
Thermokontakt



**REV S**  
5-Stufentransformator,  
für Schaltschrank-  
Einbau, ohne  
Motorschutz-  
einrichtung.



**SSW**  
5 - Stufenschalter für  
Schaltschrank-  
transformatoren



**PM-55/3 NV**  
Revisionschalter,  
3-polig +2  
Hilfskontakte  
(1S + 1Ö) für ZLT  
- Schutzart IP 67  
- Spannung bis 690V  
- Belastbar bis 25A  
- UV-Beständig  
- Gehäuse RAL 7035

Modell	Motorstrom [A]	Motorschutzschalter*	Revisionschalter	Drehzahlsteller	5-Stufentransformator mit Motorschutzeinrichtung Aufputz	5-Stufentransformator ohne Motorschutzeinrichtung Schaltschrank	5 - Stufenschalter für Schaltschranktransformatoren
Wechselstrom 1~ 230 V , 50 Hz, Kondensatormotor, 2 polig							
TCBB/2-250/H	0,5	–	PM-55/3 NV	REB- 1N(E)	N.M.	N.M.	N.M.
Wechselstrom 1~ 230 V , 50 Hz, Kondensatormotor, 4 polig							
TCBB/4-250/H	0,2	–	PM-55/3 NV	REB- 1N(E)	REV-1,5 B	REV-1,6 S	SSW
TCBB/4-315/H	0,6	–	PM-55/3 NV	REB- 1N(E)	REV-1,5 B	REV-1,6 S	SSW
TCBB/4-355/H	0,6	–	PM-55/3 NV	REB- 1N(E)	REV-1,5 B	REV-1,6 S	SSW
TCBB/4-400/H	1,1	MSD-2	PM-55/3 NV	REB- 2,5N(E)	REV-1,6 N	REV-1,6 S	SSW
TCBB/4-450/H	2,5	MSD-2	PM-55/3 NV	N.M.	N.M.	N.M.	N.M.
TCBB/4-500/H	2,8	MSD-2	PM-55/3 NV	REB-5 N	REV-3 N	REV-3 S	SSW
TCBB/4-560/L	6	MSD-2	PM-55/3 NV	–	REV-7 N	REV-7 S	SSW
TCBB/4-560/H	6	MSD-2	PM-55/3 NV	N.M.	N.M.	N.M.	N.M.
TCBB/4-630/L	7,5	MSD-2	PM-55/3 NV	N.M.	N.M.	N.M.	N.M.
Wechselstrom 1~ 230 V , 50 Hz, Kondensatormotor, 6 polig							
TCBB/6-355/H	0,4	MSD-2	PM-55/3 NV	REB- 1N (E)	REV-1,6 N	REV-1,6 S	SSW
TCBB/6-400/H	0,5	MSD-2	PM-55/3 NV	REB- 1N(E)	REV-1,6 N	REV-1,6 S	SSW
TCBB/6-500/H	1	MSD-2	PM-55/3 NV	REB- 2,5N(E)	REV-1,6 N	REV-1,6 S	SSW
TCBB/6-560/L	1,6	MSD-2	PM-55/3 NV	REB- 2,5N(E)	REV-1,6 N	REV-1,6 S	SSW
TCBB/6-630/L	2,1	MSD-2	PM-55/3 NV	REB- 2,5N(E)	REV-3 N	REV-3 S	SSW
TCBB/6-710/L	4,2	MSD-2	PM-55/3 NV	N.M.	N.M.	N.M.	N.M.

\* Bei Verwendung von 5-Stufen-Transformatoren (REV-N) nicht erforderlich  
N.R. Modell nicht Regelbar

## ZUBEHÖR

### ZUBEHÖR DREHZAHLREGLUNG TCBT (3~ 400 V)



**MSD-2**  
Motorschutzschalter  
Schalt- und  
Schutzgerät für  
Motoren mit separat  
zum Klemmenbrett  
geführten  
Thermokontakt



**FUD N S**  
Frequenzumrichter FU  
zur stufenlosen  
Drehzahlregelung von  
Ventilatoren mit  
Drehstrommotoren  
IP20 - Schaltschrank



**FUD N**  
Frequenzumrichter FU  
zur stufenlosen  
Drehzahlregelung von  
Ventilatoren mit  
Drehstrommotoren  
IP66 - Aufputz



**PM-55/3 NV**  
Revisionschalter,  
3-polig +2  
Hilfskontakte  
(1S + 1Ö) für ZLT  
- Schutzart IP 67  
- Spannung bis 690V  
- Belastbar bis 25A  
- UV-Beständig  
- Gehäuse RAL 7035



**SWG**  
**# 8000600412**  
Sollwertsteller 0-10V  
für FUW N / FUD N

Modell	Motorstrom [A]	Motorschutzschalter	Frequenzumrichter IP 66 Aufputz	Frequenzumrichter IP 20 Schaltschrank	5-Stufentransformator mit Motorschutzeinrichtung Aufputz	5-Stufentransformator ohne Motorschutzeinrichtung Schaltschrank	5 - Stufenschalter für Schaltschranktransformatoren
Drehstrom 3~400V, 50 Hz, 2-polig							
TCBT/2-250/H	0,2	MSD-2	FUD N-0,37	FUD N-0,37 S	N.M.	N.M.	N.M.
Drehstrom 3~400V, 50 Hz, 4-polig							
TCBT/4-250/H	0,2	MSD-2	FUD N-0,37	FUD N-0,37 S	RDV-0,8 N	RDV-1,2 S	SSD
TCBT/4-315/H	0,3	MSD-2	FUD N-0,37	FUD N-0,37 S	RDV-0,8 N	RDV-1,2 S	SSD
TCBT/4-355/H	0,3	MSD-2	FUD N-0,37	FUD N-0,37 S	RDV-0,8 N	RDV-1,2 S	SSD
TCBT/4-400/H	0,5	MSD-2	FUD N-0,37	FUD N-0,37 S	RDV-0,8 N	RDV-1,2 S	SSD
TCBT/4-450/H	1,1	MSD-2	FUD N-0,37	FUD N-0,37 S	RDV-1,2 N	RDV-1,2 S	SSD
TCBT/4-500/H	1,5	MSD-2	FUD N-0,55	FUD N-0,55 S	RDV-2,5 N	RDV-2,5 S	SSD
TCBT/4-560/L	2,2	MSD-2	FUD N-0,75	FUD N-0,75 S	RDV-2,5 N	RDV-2,5 S	SSD
TCBT/4-560/H	2,4	MSD-2	FUD N-1,10	FUD N-1,10 S	N.M.	N.M.	N.M.
TCBT/4-630/L	3,4	MSD-2	FUD N-1,50	FUD N-1,50 S	N.M.	N.M.	N.M.
TCBT/4-630/H	3,6	MSD-2	FUD N-1,50	FUD N-1,50 S	N.M.	N.M.	N.M.
TCBT/4-710/L	3,7	MSD-2	FUD N-1,50	FUD N-1,50 S	N.M.	N.M.	N.M.
TCBT/4-710/H	6,1	MSD-2	FUD N-3,00	FUD N-3,00 S	N.M.	N.M.	N.M.
TCBT/4-800/L	6,5	MSD-2	FUD N-3,00	FUD N-3,00 S	N.M.	N.M.	N.M.
TCBT/4-800/K	8,8	MSD-2	FUD N-4,00	FUD N-4,00 S	N.M.	N.M.	N.M.
TCBT/4-800/G	11,1	MSD-2	FUD N-5,50	FUD N-5,50 S	N.M.	N.M.	N.M.
TCBT/4-800/H	13,0	MSD-2	FUD N-5,50	FUD N-5,50 S	N.M.	N.M.	N.M.
Drehstrom 3~400V, 50 Hz, 6-polig							
TCBT/6-355/H	0,2	MSD-2	FUD N-0,37	FUD N-0,37 S	RDV-0,8 N	RDV-1,2 S	SSD
TCBT/6-400/H	0,2	MSD-2	FUD N-0,37	FUD N-0,37 S	RDV-0,8 N	RDV-1,2 S	SSD
TCBT/6-450/H	0,4	MSD-2	FUD N-0,37	FUD N-0,37 S	RDV-0,8 N	RDV-1,2 S	SSD
TCBT/6-500/H	0,5	MSD-2	FUD N-0,37	FUD N-0,37 S	RDV-0,8 N	RDV-1,2 S	SSD
TCBT/6-560/H	0,8	MSD-2	FUD N-0,37	FUD N-0,37 S	RDV-0,8 N	RDV-1,2 S	SSD
TCBT/6-630/L	1,3	MSD-2	FUD N-0,37	FUD N-0,37 S	RDV-2,5 N	RDV-2,5 S	SSD
TCBT/6-630/H	2,7	MSD-2	FUD N-1,10	FUD N-1,10 S	RDV-3,2 N	RDV-5 S	SSD
TCBT/6-710/L	2,0	MSD-2	FUD N-0,75	FUD N-0,75 S	N.M.	N.M.	N.M.
TCBT/6-710/H	3,1	MSD-2	FUD N-1,50	FUD N-1,50 S	N.M.	N.M.	N.M.

\* Bei Verwendung von 5-Stufen-Transformatoren (RDV-N) oder Frequenzumrichtern (FU\_ N) nicht erforderlich  
N.M. Nicht möglich

## ZUBEHÖR

### MONTAGEZUBEHÖR

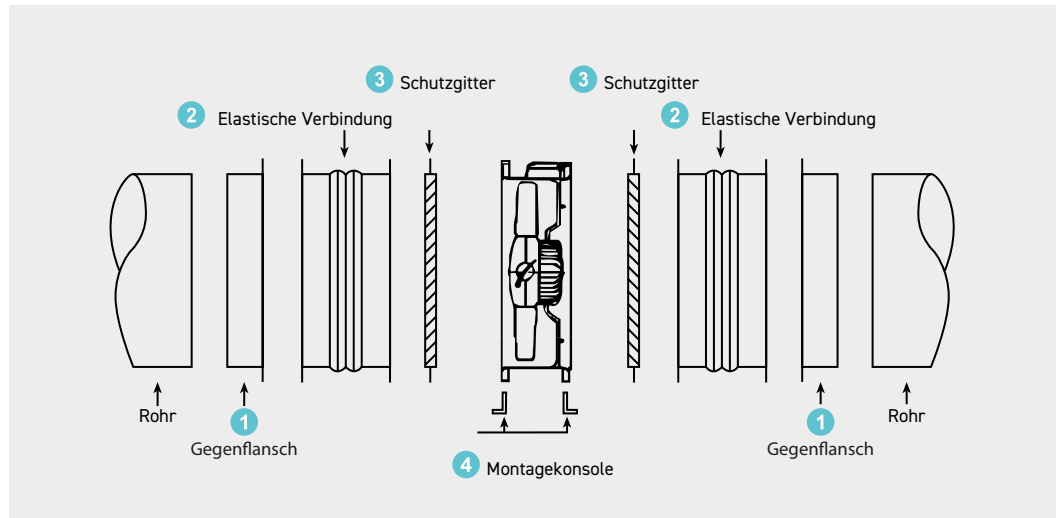

Modell	3 Schutzgitter		1 Gegenflansch	4 Montagekonsole	Ansaugdüse mit Schutzgitter	2 Elastische Verbindung	Elastische Verbindung (ATEX)	Rohrschalldämpfer	Rohrverschlussklappe
	Saugseite	Druckseite							
TCBB / TCBT 250	DEF-250 A	DEF-250 A	FL-250/435	PIE-250	TAD-250/435 N	ELV-250/435	-	TAA-250	TSK-250
TCBB / TCBT 315	DEF-315 A	DEF-315 A	FL-315	PIE-315	TAD-315 N	ELV-315	ELV-315 Ex	TAA-315	TSK-315
TCBB / TCBT 355	DEF-355 A	DEF-355 A	FL-355/560	PIE-355	TAD-355/560 N	ELV-355/560	ELV-355/560 Ex	TAA-355	TSK-355
TCBB / TCBT 400	DEF-400 A	DEF-400 A	FL-400/630	PIE-400	TAD-400/630 N	ELV-400/630	ELV-400/630 Ex	TAA-400	TSK-400
TCBB / TCBT 450	DEF-450 A	DEF-450 A	FL-450	PIE-450	TAD-450 N	ELV-450	ELV-450 Ex	TAA-450	TSK-450
TCBB / TCBT 500	DEF-500 A	DEF-500 A	FL-500/710	PIE-500	TAD-500/710 N	ELV-500/710	ELV-500/710 Ex	TAA-500	TSK-500
TCBB / TCBT 560	DEF-560 A	DEF-560 A	FL-560	PIE-560	TAD-560 N	ELV-560	ELV-560 Ex	TAA-560	TSK-560
TCBB / TCBT 630	DEF-630 A	DEF-630 A	FL-630/905	PIE-630	TAD-630 N	ELV-630/905	ELV-630/905 Ex	TAA-630	TSK-630
TCBT 4-710/H	DEF-710 A	DEF-710 D	FL-710/1100	PIE-710	TAD-710/1100 N	ELV-710/1100	ELV-710/1100 Ex	TAA-710	TSK-710
TCBT 4-710/L	DEF-710 A	DEF-710 D	FL-710/1100	PIE-710	TAD-710/1100 N	ELV-710/1100	-	TAA-710	TSK-710
TCBB / TCBT 6-710	DEF-710 A	DEF-710 A	FL-710/1100	PIE-710	TAD-710/1100 N	ELV-710/1100	-	TAA-710	TSK-710
TCBT 800	DEF-800 A	DEF-800 D	FL-800	PIE-800	TAD-800 N	ELV-800	-	TAA-800	TSK-800